



Adventurer™ Balances Instruction Manual



REVISION HISTORY

Date	Version	Description
May 6, 2023	E	Corresponding contents have been added: <ul style="list-style-type: none">● Added User Management function (Admin amount: 1; Supervisor amount: 2; Operator amount: 10).● Added Batch Printing function in the basic weighing mode (Up to 20 samples can be weighed in a batch).● Added Label Printing function.● Added Auto Off function.● Added Output Format setting.● Added seconds setting to the Time Setup function.● Added the following models: AX623/6202/12001 and AX5 related models.
Sep 27, 2023	F	● Updated company address
Nov 1, 2023	G	● Updated product specification ● Updated display information in 4.5

TABLE OF CONTENTS

1. INTRODUCTION	3
1.1 Description	3
1.2 Features	3
1.3 Definition of Signal Warnings and Symbols	3
1.4 Safety Precautions	3
1.5 Intended Use	4
2. INSTALLATION	4
2.1 Unpacking	4
2.2 Selecting the Location	4
2.3 Leveling the Equipment	4
2.4 Connecting Power	6
2.5 Connecting the Interface	6
2.6 Initial Calibration	6
3. OPERATION	7
3.1 Overview of Display, Home Screen	7
3.2 Principal Functions and Main Menu	9
3.3 Overview of Parts and Features – Draft Shield Models	10
3.4 Overview of Parts and Features – Non Draft Shield Models	10
4. APPLICATIONS	10
4.1 Weighing	11
4.1.1 Batch Printing	12
4.1.2 Item Settings	13
4.1.3 Sample Name	14
4.1.4 Save to USB	14
4.1.5 Auto Save to USB	14
4.2 Parts Counting	14
4.2.1 Item Settings	15
4.3 Percent Weighing	17
4.3.1 Item Settings	17
4.4 Dynamic Weighing	18
4.4.1 Item Settings	18
4.5 Density Determination	19
4.5.1 Measuring the Density of a Solid Using Water (default)	19
4.5.2 Measuring the Density of a Buoyant Material Using Water	20
4.5.3 Measuring the Density of a Solid Using an Auxiliary Liquid	20
4.5.4 Measuring the Density of a liquid using a Calibrated Sinkers (not supplied)	21
4.5.5 Measuring the Density of Porous Material Using Oil	22
4.6 Check Weighing	24
4.6.1 Item Settings	26
4.7 Display Hold	26
4.7.1 Display Hold	26
4.7.2 Peak Hold	27
4.7.3 Item Settings	27
4.8 Totalization	27
4.9 Formulation	28
4.9.1 Item Settings	29
4.10 Additional Features	29
4.10.1 Weigh Below	29
5. MENU SETTINGS	30
5.1 Menu Navigation	30
5.1.1 Changing Settings	31
5.2 Calibration	32
5.2.1 Calibration sub-menu (InCal models)	32
5.2.2 Internal Calibration	32
5.2.3 Automatic Calibration	32
5.2.4 AutoCal™ Adjustment	33
5.2.5 Span Calibration	33
5.2.6 Linearity Calibration	33
5.2.7 Calibration Test	33
5.3 Balance Setup	34
5.3.1 Balance Set-up sub-menu	34

5.3.2	Language	34
5.3.3	User Setting.....	34
5.3.4	Filter Level.....	35
5.3.5	Auto Zero Tracking.....	35
5.3.6	Auto Tare.....	35
5.3.7	Graduations.....	35
5.3.8	Date & Time	35
5.3.9	Approved Mode	36
5.4	Weighing Units	36
5.4.1	Units Sub-menu.....	37
5.5	Data Maintenance	37
5.5.1	Data Maintenance sub-menu	37
5.5.2	Export to USB.....	37
5.5.3	Import from USB.....	38
5.5.4	Balance Info	38
5.6	Communication	38
5.6.1	RS-232 Standard:.....	38
5.6.2	Print Settings	39
5.6.3	Save to USB.....	40
5.7	GLP and GMP Data	41
5.7.1	GLP Data Sub-menu.....	41
5.7.2	Header.....	41
5.7.3	Balance Name.....	41
5.7.4	User Name	41
5.7.5	Project Name.....	41
5.8	Factory Reset.....	41
5.9	User Management.....	41
5.9.1	User Profiles.....	42
5.9.2	Change Password.....	43
5.9.3	Auto Standby.....	43
6.	LEGAL FOR TRADE (LFT).....	44
6.1	Settings	44
6.2	Verification.....	44
6.3	Sealing	44
7.	PRINTING	45
7.1	Connecting, Configuring and Testing the Printer/Computer Interface	45
7.2	Output Format	45
7.3	Printout Examples	46
8.	MAINTENANCE	48
8.1	Calibration	48
8.2	Cleaning	48
8.3	Troubleshooting	49
8.4	Service Information	49
9.	TECHNICAL DATA.....	50
9.1	Specifications	50
9.2	Drawings and Dimensions	60
9.3	Parts and Accessories	60
9.4	Communication	61
9.4.1	Interface Commands.....	61
9.4.2	RS232 (DB9) Pin Connections.....	61
9.5	The USB Interface.....	61
10.	SOFTWARE UPDATES.....	63
11.	COMPLIANCE.....	64

1. INTRODUCTION

1.1 Description

The Adventurer balance is a precision weighing instrument that will provide you with years of service if properly cared for. The Ohaus Adventurer balances are available in capacities from 120 grams to 12,000 grams.

1.2 Features

Touch Controls: Quick, graphical access to all control functions, over a dozen applications and many features.

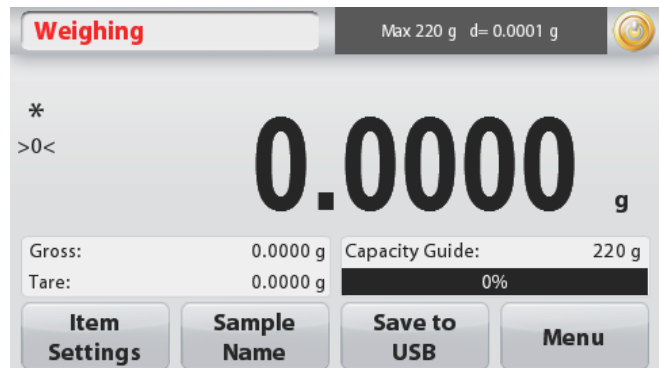

1.3 Definition of Signal Warnings and Symbols

Safety notes are marked with signal words and warning symbols. These show safety issues and warnings. Ignoring the safety notes may lead to personal injury, damage to the instrument, malfunctions and false results.

Signal Words

WARNING	For a hazardous situation with medium risk, possibly resulting in injuries or death if not avoided.
CAUTION	For a hazardous situation with low risk, resulting in damage to the device or the property or in loss of data, or injuries if not avoided.
Attention Note	For important information about the product. May lead to equipment damage if not avoided. For useful information about the product

Warning Symbols



General Hazard



Electrical Shock Hazard



Explosion hazard

1.4 Safety Precautions



CAUTION: Read all safety warnings before installing, making connections, or servicing this equipment. Failure to comply with these warnings could result in personal injury and/or property damage. Retain all instructions for future reference.

- Before connecting power, verify that the AC adapter's input voltage range and plug type are compatible with the local AC mains power supply.
- Do not position the equipment such that it is difficult to reach the power connection.
- Make sure that the power cord does not pose a potential obstacle or tripping hazard.
- Operate the equipment only under ambient conditions specified in these instructions.
- This equipment is for indoor use only.
- Do not operate the equipment in wet, hazardous or unstable environments.
- Do not allow liquids to enter the equipment.
- Do not load the equipment above its rated capacity.
- Do not drop loads on the platform.
- Do not place the equipment upside down on the platform.
- Use only approved accessories and peripherals.

- Disconnect the equipment from the power supply when cleaning.
- Service should only be performed by authorized personnel.



WARNING: Electrical shock hazards exist within the housing. The housing should only be opened by authorized and qualified personnel. Remove all power connections to the unit before opening.



WARNING: Never work in an environment subject to explosion hazards! The housing of the instrument is not gas tight. (Explosion hazard due to spark formation, corrosion caused by the ingress of gases).

1.5 Intended Use

This instrument is intended for use in laboratories, pharmacies, schools, businesses and light industry. It must only be used for measuring the parameters described in these operating instructions. Any other type of use and operation beyond the limits of technical specifications, without written consent from OHAUS, is considered as not intended.

This instrument complies with current industry standards and the recognized safety regulations; however, it can constitute a hazard in use.

If the instrument is not used according to these operating instructions, the intended protection provided by the instrument may be impaired.

2. INSTALLATION

2.1 Unpacking

Carefully remove your Adventurer balance and each of its components from the package. The included components vary depending on the balance model (see table below). Save the packaging to ensure safe storage and transport. Please read the manual completely before installing and using the Adventurer balance to avoid incorrect operation.

Included Components

- Balance
- Power Adapter
- Wind Ring (only for 0.01mg, 0.1 mg and 1 mg models)
- Warranty Card
- Software Compact Disk

2.2 Selecting the Location

Avoid excessive vibrations, heat sources, air current, or rapid temperature changes. Allow sufficient space.



2.3 Leveling the Equipment

The Adventurer has a level bubble in a small round window beside the display.

To level the balance, adjust the 4 **Leveling Feet** until the bubble is centered in the circle. See the Level Assist section below on information about how and which feet to turn. Be sure the equipment is level each time its location is changed.



Level Assist

A level assist function is available to help leveling the Adventurer. There are two ways to access the function:

1. **Weighing Application** -> **Item Settings** -> **Level Assist**. See section 4.1.1 for more information.
2. **Main Menu** -> **Balance Setup** -> **User Settings** -> **Level Assist**. See section 5.3.3 for more information.

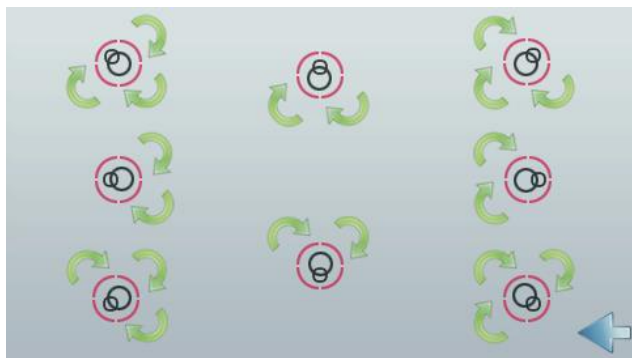

Rotate the feet according to the image above depending on the location of the level bubble until the bubble is centered.

2.4 Connecting Power

Connect the DC output connector to the power receptacle on the rear of the balance. Then connect the AC power cord to a suitable electrical outlet.



CAUTION: For use with CSA certified (or equivalent approved) power source, which must have a limited current output.



Attention: For optimal weighing performance, allow the balance to warm up for 60 minutes prior to use.

2.5 Connecting the Interface

Use the built-in RS-232 Port to connect either to a computer or a printer with a standard (straight-through) serial cable. Or connect using the scale's USB port.

Interface connections on the rear of the balance:

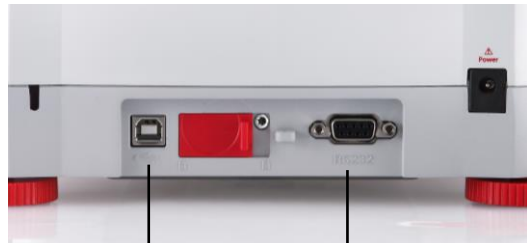

USB1

RS232

USB connection on the front of the balance:



USB2

USB1: Used to connect to PC only

USB2: Used to connect a USB flash driver only

RS232: Used to connect to PC or Printer

Note: For configuration and interface commands, see the Communication Menu Settings section. For Connecting, Configuring and Testing the Printer/Computer Interface, and for sample Print Output Formats, see the Printing section.

2.6 Initial Calibration

When the Balance is first installed, and when it is moved to another location, it must be calibrated to ensure accurate weighing results. Most Adventurer Balances have built in AutoCal which can calibrate the balance automatically and does not require calibration masses. If preferred, the balance can be manually calibrated with external masses. Have the appropriate calibration masses available before beginning calibration. Refer to the Calibration Section for masses and calibration procedure.

▣ AutoCal™

Fully automatic internal calibration system that assists with routine maintenance by automatically calibrating the balance daily is available on most models.

Automatically calibrates the system when it senses a temperature change sufficient enough to affect weighing accuracy (>1.5°C), or every 11 hours.

▣ External Calibration

Select precision models feature traditional external calibration in which external weights (user's choice of calibration weight values) are used to calibrate the balance to ensure accuracy.

3. OPERATION

3.1 Overview of Display, Home Screen

This equipment utilizes a touch-sensitive display with *Touch* areas and Buttons to control the equipment's functions.

CONTROLS

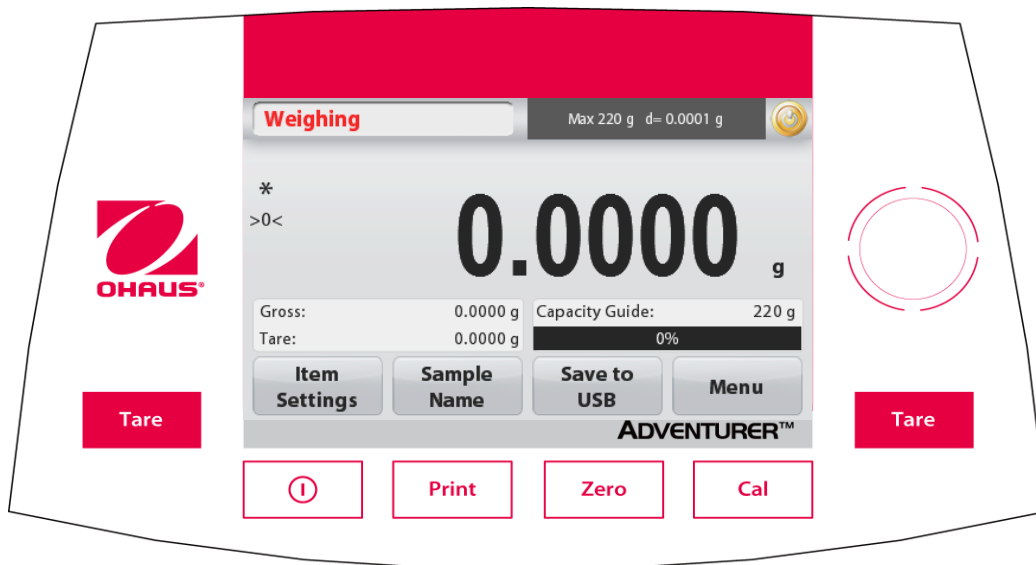

Button	Action
	User logout button
	Short Press (if powered Off): Turns on the scale Long Press (if powered On): Turns off the scale Note: The balance will automatically power on when power is connected.
	Short Press: Prints the present data to a printer or a computer.
	Short Press: Perform Zero operation
	Short Press: Perform Calibration operation
	Short Press: Perform Tare operation

Boot-up login interface

Enter the boot-up login interface:

Case 1: Power on and boot up
Immediately after Power On, the display screen of the balance will enter the boot-up login interface.

Case 2: After manual shutdown, boot up again.
Manually short press the mechanical power button on the control panel to enter the boot-up login interface.

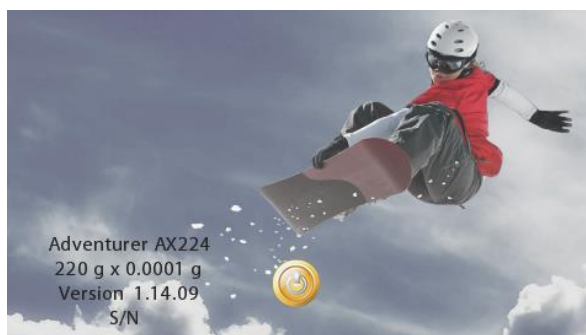

Log in to the home screen:

Short press  button, select a user name, click

the  button, and enter the home screen after entering the password.

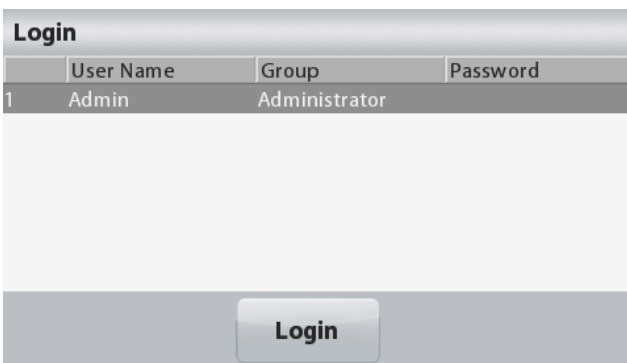

Main Application Screen

Application

Instructional Messages

Stability (*), Net (NET), Gross (G) and/or center of zero (>0<) indicators

Reference Fields



User logout button

Result Field: Information varies by application
Touch **g** to change unit

Application Buttons:
Functions vary by application

3.2 Principal Functions and Main Menu

Weighing: Press **Zero** to set the display to zero. Place an item on the pan. Display indicates gross weight.

Taring: With no load on the pan, press **Zero** to set the display to zero. Place an empty container on the pan and press **Tare**. Add material to the container and its net weight is displayed. Remove container and container's weight appears as a negative number. Press **Tare** to clear.

Zero: Press **Zero** to zero the balance

MENU & SCREEN NAVIGATION

Touch **Menu** to open the menu list.



Calibration:

Touch to view calibration options.



Balance Setup:

Touch to view and change balance settings.



Weighing Units:

Touch to view and change weighing units.



Data Maintenance:

Touch to view data maintenance settings.



GLP and GMP Data:

Insert user data for traceability.



Communication:

Touch to view COM Device Settings and Print Settings.

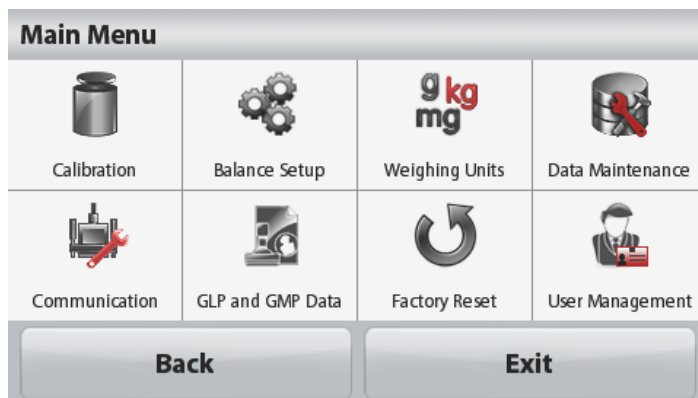

Factory Reset:

Touch to do a Factory reset of menu settings.



User Management

Touch this button to enter the sub-menu: **User Profiles** (to add or delete users), **Change password** and **Auto Standby**.

3.3 Overview of Parts and Features – Draft Shield Models

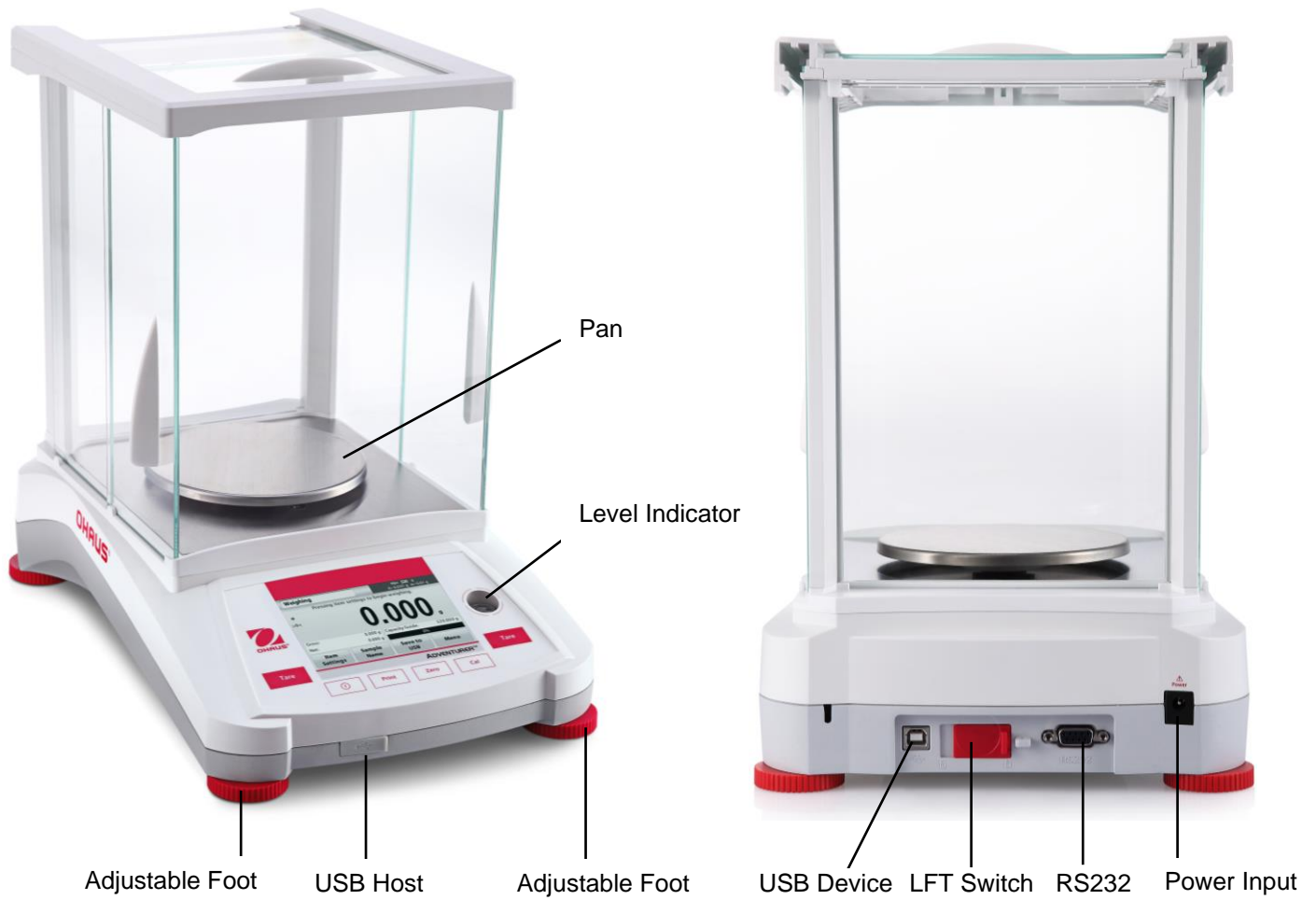

3.4 Overview of Parts and Features – Non Draft Shield Models

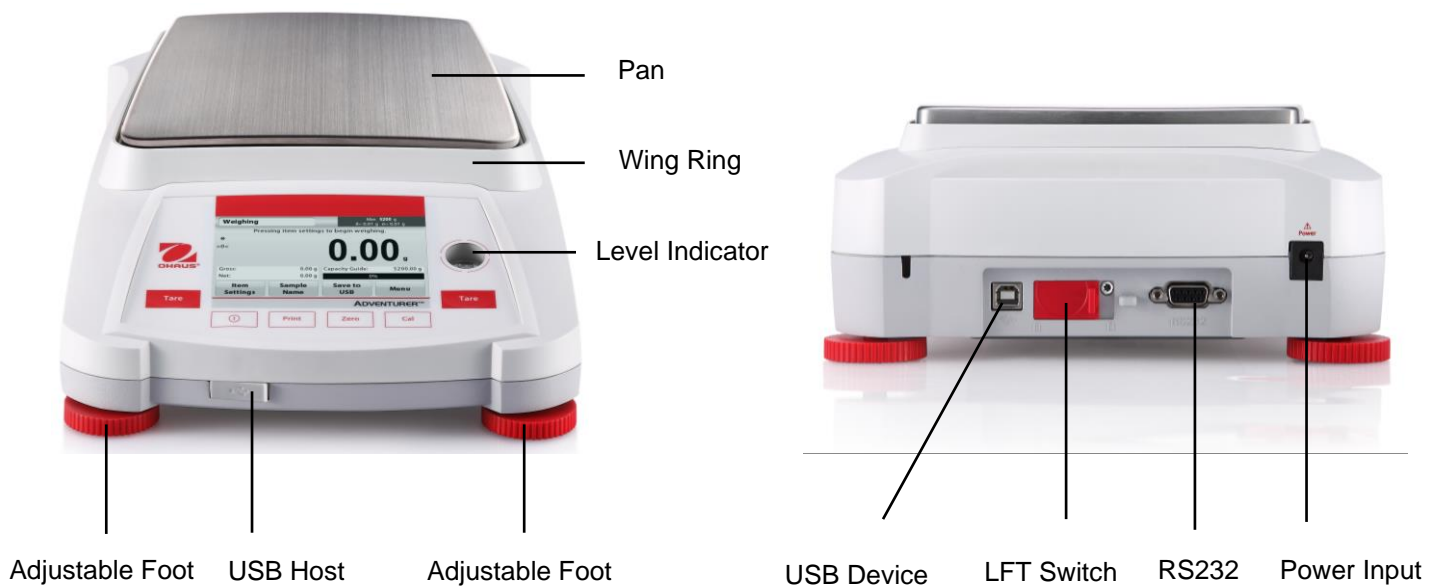

4. APPLICATIONS

The balance can be configured to operate in various Application modes. Touch the top left Application field (weighing in the example below):

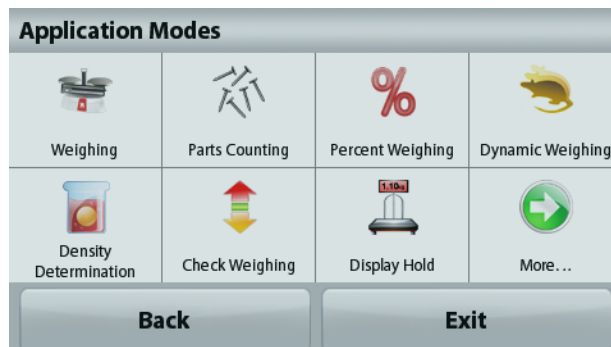
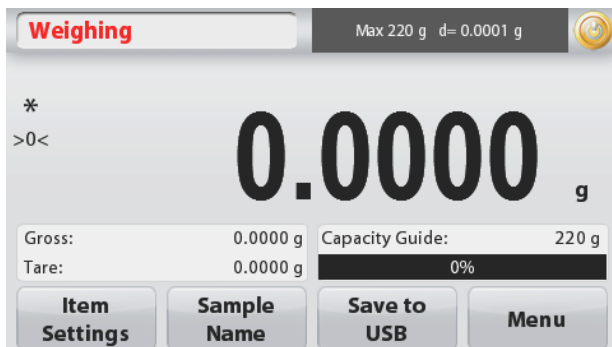

The Adventurer Balance has 9 application modes, as follows:

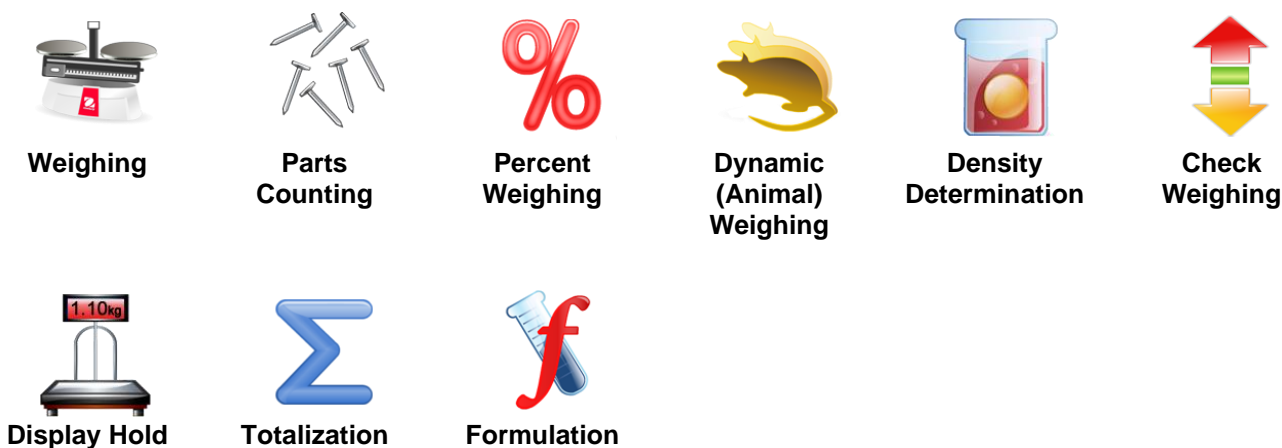

4.1 Weighing

Note: Before using any application, be sure the balance has been leveled and calibrated.

Use this application to determine the weight of items in the selected unit of measure.

Weighing

1. In the upper left portion of the home screen, select Weighing (this application is the default).
2. Press **Tare** or **Zero** if necessary to begin.
3. Place objects on the pan to display the weight. When stable, the * appears.
4. The resulting value is displayed in the main Display Line in the active unit of measure.

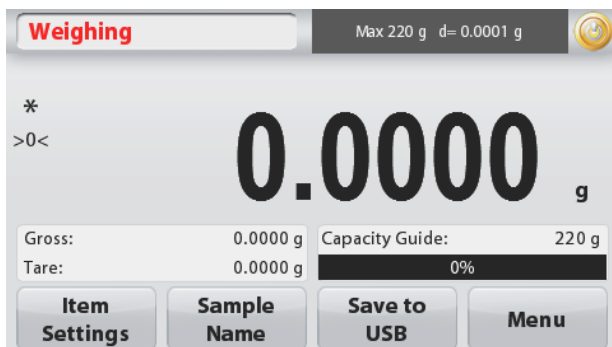

The **WEIGHING** Home screen

Main Display Line

Touch **g** to change unit

Reference Fields

Application Buttons



Application Icon

4.1.1 Batch Printing

When the batch printing function is set to ON, the weighing results of multiple samples in the same batch can be displayed in one print record in the weighing mode.

Steps:

1. In the weighing mode, short press the Item Settings to enter the sub-menu.
2. Select batch printing, select ON, and then short press Exit to return to the home screen.

3. Short press the Zero button to clear.
4. Put the container on the pan, and when the reading is stable, the weighing result will be displayed on the screen.
5. Short press the Tare button to set the tare, and the reading on the screen will be 0.

6. Short press the **Start** button and place Sample 1. When the reading is stable, the weighing result will be displayed on the screen.

7. Short press the **ACCEPT** button to save the weighing result of Sample 1. At this time, the screen will show "Place Sample 2".

8. Remove Sample 1 and place Sample 2. When the reading is stable, the weighing result will be displayed on the screen, and then short press the **ACCEPT** button to save the weighing result.

9. If there are more samples to weigh, repeat Step 8.

Note: Up to 20 samples can be weighed in a batch.

10. After all the samples are weighed, short press the Stop button, and the weighing results of all samples will be displayed on the screen. If you need a bulk print, short press the Batch Printing button; if you do not need a bulk print, short press the Exit button to return to the home screen.

The interface shows the 'Weighing' menu with options: Minimum Weight, Capacity Bar, Batch Printing, Weighing Units, Filter Level, GLP and GMP Data, Print Settings, and Level Assist. The 'Batch Printing' option is selected and set to 'On'.

The weighing process is shown in three stages:

- Initial State:** Weighing mode, Max 220 g, d=0.0001 g. The display shows 0.0000 g. Buttons: Item Settings, Sample Name, Start, Menu.
- Sample 1:** "Place sample 1. Press Accept." The display shows 2.3371 g. Buttons: Item Settings, Stop, Accept, Menu.
- Sample 2:** "Place sample 2. Press Accept." The display shows 3.9000 g. Buttons: Item Settings, Stop, Accept, Menu.

The final screen displays the results in a table:

Samples	Weight
1	2.3376 g
2	3.9002 g

Buttons at the bottom: Batch Printing, Exit.

4.1.2 Item Settings

To view or adjust the current settings

Touch the **Item Settings** button. The Settings screen appears.

Minimum Weight: establish a minimum weight value to be used to verify a reading. If an actual weight is below the established Minimum Weight value, it is flagged by a color change: **yellow**.

To adjust the Minimum Weight value, touch the **Minimum Weight** button.

A numeric input window appears.

Use the keys to enter the desired Minimum Weight, then press **Save**.

The display reverts to the previous screen.

To return to the Weighing home screen, touch **Exit** at the bottom of that screen.

Capacity Bar: When set to ON, a capacity bar is displayed in the reference field. The capacity guide will show the current weight as a percentage of balance capacity.

If Capacity Bar is set to OFF, the reference field will show Minimum Weight and Sample Name.

Weighing Units: Change the displayed unit. See section 5.4 for more information

Note: Touching the weighing unit from application home screen will also open the Weighing Units screen.

Filter Level: Change Filtering level. See section 5.3.4 for more information

GLP & GMP Data: See section 5.7 for more information

Print settings: Change printing settings. See section 7 for more information.

Level Assist: Instructions on how to move the balance feet to level the balance.

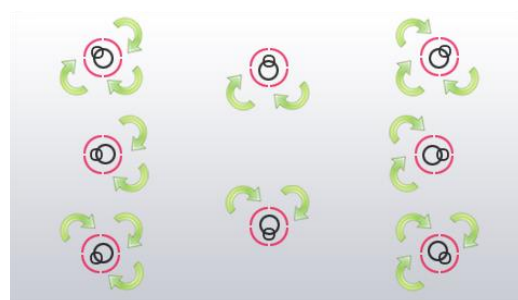
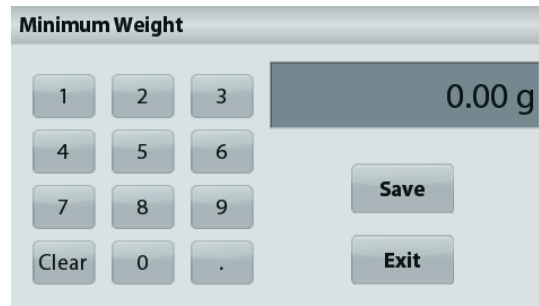
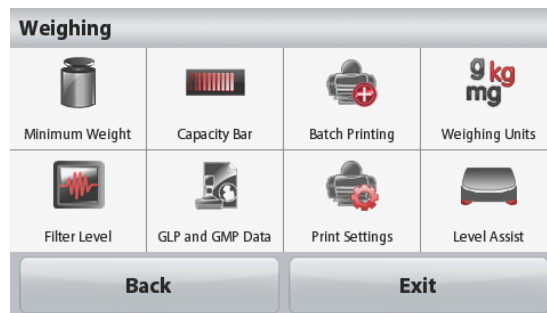

4.1.3 Sample Name

Press this button to add a sample name. An alphanumeric input window appears. Press  to alternate between Lower and Upper case characters.

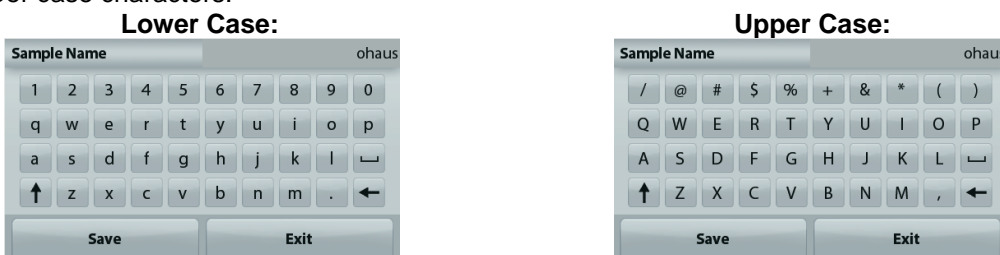

Key in the desired sample name and press Save to save the name and return to weighing home screen.

4.1.4 Save to USB

Insert the USB flash drive into the USB slot located on the front of the balance. Next, press the Save to USB button to save the data to the USB flash drive. Once saved, the button will momentarily change color to orange.

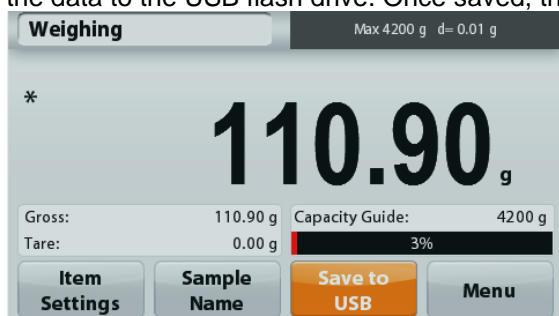

Notes: The first time a USB flash drive is connected to the balance there might be some delay time before the button **Save to USB** works. This is due to that the balance is creating the necessary folders on the USB flash drive where the data will be stored.

The Density Determination and Check Weighing applications do not have a Save to USB button.



CAUTION:

The weighing data will be saved to USB every day. However, if different weighing modes are used the data will be separately saved to individual files.

Depending on the USB drive used, all data might not be transferred from the balance or the display might freeze. If this happens, unplug the USB flash drive and try another USB flash drive.

Ohaus takes no responsibility if data on USB flash drive is erased or if the USB flash drive breaks while it is connected to the balance.

To minimize the risk of problems arising, Ohaus suggests using a high quality USB flash drive.

4.1.5 Auto Save to USB

Data can be automatically saved to USB when AutoPrint is set On in the USB communication. The On Stable, Interval Auto Print functions can be selected and used for Auto Save to USB.

4.2 Parts Counting

Note: Before using any application, be sure the balance has been leveled and calibrated. Use this application to count samples of uniform weight.

Parts Counting

1. In the upper left portion of the home screen, select Parts Counting
2. Press **Tare** or **Zero** if necessary to begin.
3. Place objects on the pan to display the weight. When stable, the * appears.
4. The resulting value is displayed in the main Display Line in pieces (PCS).

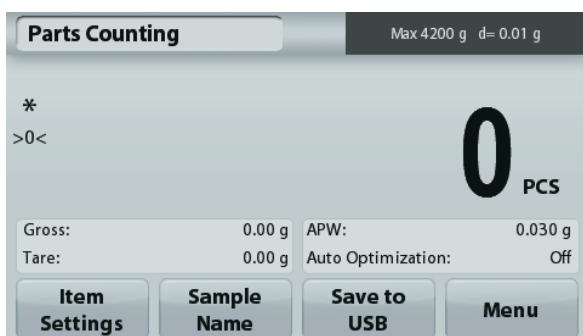

The **Parts Counting** Home screen

Main Display Line

Reference Fields

Application Buttons



Application Icon

4.2.1 Item Settings

To view or adjust the current settings

Touch the **Item Settings** button. The Settings screen appears.

Samples: The sample size can be 1 to 10 000 pieces. The default sample size is 10. Once a sample size is changed, the balance will immediately open the recalculate APW screen, expecting to establish a new APW.

To adjust the sample size, touch the **Samples** button.

A numeric input window appears.

Use the keys to enter the desired sample size, then press **Save**.

The next screen appears, with the message to place the reference weight on the pan.

Place the reference weight on the pan, then touch **Accept** to capture the value, the screen shows number of pcs.

Establish an Average Piece Weight (APW):

Each time a new type of part is counted, the nominal weight of one piece (Average Piece Weight or APW) must be established using a small quantity of pieces. This APW is stored until replaced by another APW.

There are two methods to establish the APW value:

1. The actual APW is known
2. The APW must be derived by weight. For this case the current sample size will be used

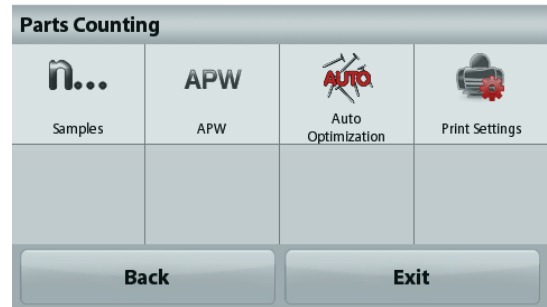

Set a *known* Average Piece Weight (APW)

To adjust the APW value directly, touch the **APW** button. A numeric input window appears.

Key in the desired APW Weight, then press **Save**.

The display returns to the application home screen with the new APW value in the reference field.



Set a new Average Piece Weight (APW) – Derived

To establish a new APW, place the reference weight on the pan and press **Accept** to continue.

Note: The sample size that is displayed will be used. To use a different sample size, change that first. (See above.)

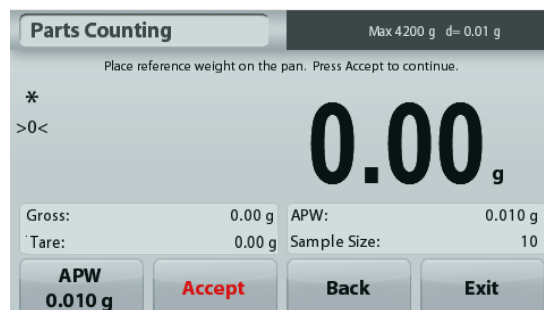

The home screen shows the number of pieces at the new APW



Auto Optimization: When set to **On**, improves counting accuracy by re-calculating the piece weight automatically as parts are added. Default is **Off**.

Notes:

APW Optimization occurs only when the number of pieces added to the pan is between one and three times the number already on the pan.

If the APW is entered manually by the numeric keypad, APW auto optimization will not occur.

Print settings: Change printing settings. See section 7 for more information.

Note: The **Save to USB** button will only appear after a USB flash drive has been connected to the balance. See section 4.1.4 for more information.

4.3 Percent Weighing

Note: Before using any application, be sure the balance has been leveled and calibrated.

Use Percent Weighing to measure the weight of a sample displayed as a percentage of a pre-established reference weight.

The default (or last) reference weight is displayed.

Percent Weighing

1. In the upper left portion of the home screen, select Percent Weighing.
2. Place an object on the pan. The difference between the sample and the reference weight is displayed as a percentage.



The **Percent Weighing** Home screen

Main Display Line

Reference Fields

Application Buttons



Application Icon

4.3.1 Item Settings

To view or adjust the current settings

Touch the **Item Settings** button. The Settings screen appears.

Recalculate Ref. Wgt: To establish a new reference weight value, touch the recalculate reference weight button.

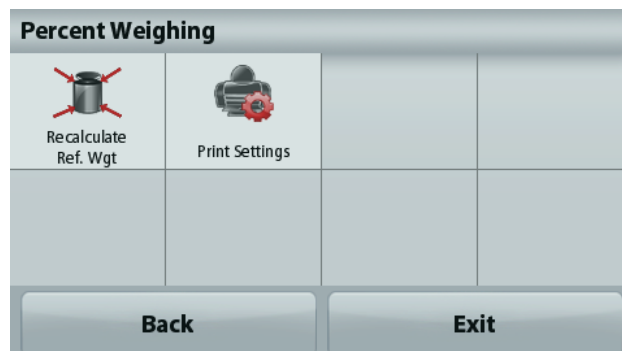

Follow the screen instructions to establish a new reference weight.

Alternatively, press the **Ref. Weight** button from the Percent Weighing Recalculate Ref. Wgt screen to establish a new reference weight manually through a numerical keypad.

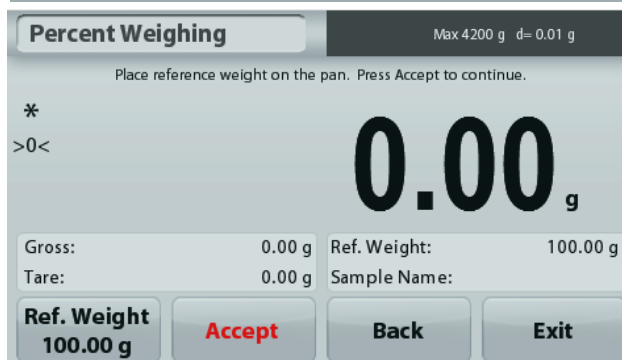

Print settings: Change printing settings. See section 7 for more information.

Note: The **Save to USB** button will only appear after a USB flash drive has been connected to the balance. See section 4.1.4 for more information.

4.4 Dynamic Weighing

Note: Before using any application, be sure the balance has been leveled and calibrated.

Use this application to weigh an unstable load, such as a moving animal. Two different start/reset modes can be selected: **Manual** (start and stop via key press) and **Automatic** (start and stop automatically).

Dynamic Weighing – Manual (default)

1. In the upper left portion of the home screen, select Dynamic Weighing
2. Place objects on the pan and press the **Start** button.



The **Dynamic Weighing** Home screen

Main Display Line

Reference Fields

Application Buttons



Application Icon

3. The balance begins a countdown (averaging process). During the countdown, the information line displays the time remaining.
If necessary, press **Stop** to quit.
4. When the countdown ends, the result line is displayed and held. Press **Clear** to clear the held weight and return to the initial screen.

Note: Clear the pan before beginning a new Dynamic weighing cycle.

4.4.1 Item Settings

To view or adjust the current settings

Touch the **Item Settings** button. The Settings screen appears.

Averaging Time: Set the averaging time to a value between 1 and 99 seconds. Default is 5 seconds.

Automatic Mode: When set to On, the cycle begins when an object is placed on the pan, and the held value is automatically reset when the object is removed from the pan.

Sample Name: Assign a name to the sample.

Print settings: Change printing settings. See section 7 for more information.

Note: The **Save to USB** button will only appear after a USB flash drive has been connected to the balance.

See section 4.1.4 for more information.

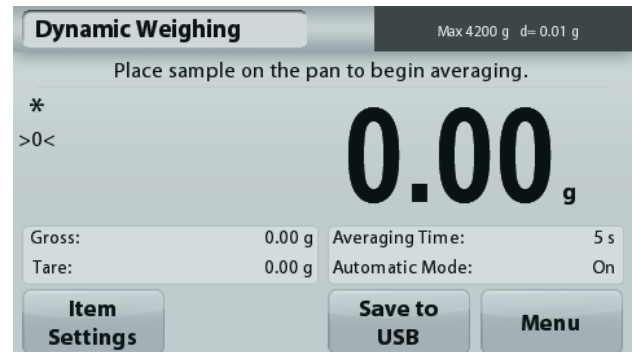
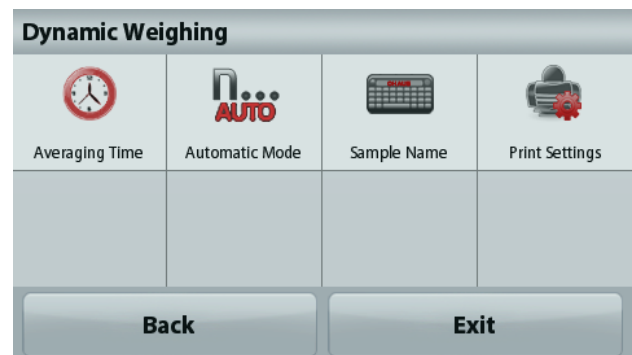

4.5 Density Determination

Note: Before using any application, be sure the balance has been leveled and calibrated.

Use this application to determine an object's density. Four types of density determination can be made:

1. Solids denser than water
2. Solid less dense than water
3. Liquid density
4. Porous material (impregnated with oil)

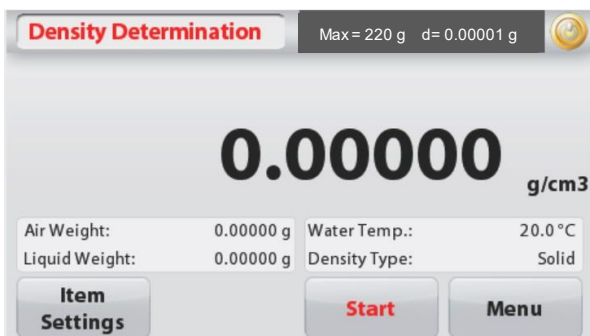

The Density Determination Home screen

Main Display Line
(showing the density result in selected display resolution)



Application Icon

Reference Fields

Function Buttons

Display resolution of density's weighing result

To set the display resolution, navigate to **Item Setting > g/cm³**.

Options of display resolution

Balance Readability	Options of display resolution	Default value
d = 0.00001 g	0.00001g/cm ³ , 0.0001g/cm ³ , 0.001g/cm ³ , 0.01g/cm ³	0.001g/cm ³
d = 0.0001 g	0.0001g/cm ³ , 0.001g/cm ³ , 0.01g/cm ³ , 0.1g/cm ³	0.001g/cm ³
d = 0.001 g	0.001g/cm ³ , 0.01g/cm ³ , 0.1g/cm ³	0.001g/cm ³
d = 0.01 g	0.01g/cm ³ , 0.1g/cm ³	0.01g/cm ³
d = 0.1 g	0.1g/cm ³	0.1g/cm ³

Note: 0.00001g balance does not offer 0.1g/cm³ option of display resolution.

4.5.1 Measuring the Density of a Solid Using Water (default)

Press the **Item Settings** button to open the Density Determination **Settings** screen.

Confirm the following **Setups** are selected:

- ✓ **Density Type: Solid**
- ✓ **Auxiliary Liquid: Water**
- ✓ **Porous Material: Off**
- ✓ **g/cm³: to select the display resolution of Density's weighing result.**

To adjust the water temperature value, touch the **Water Temp.** button.

The balance calculates water density based on the water temperature value entered.

Measure the actual water temperature using a precision thermometer.

A numeric input window appears.

Enter the actual water temperature, then press **Save**.

To return to the Density Determination home screen, touch **Back**.

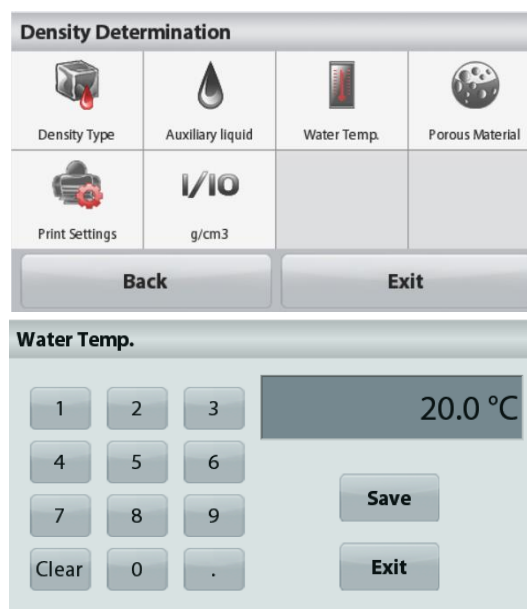

To measure the density,

Step 1 of 2 – Weigh the Sample in Air.

Press **Start**. Follow screen instructions, then press **Accept** to store the dry sample weight (“in air”).



Step 2 of 2 – Weigh the Sample Submerged in the Liquid.

Follow the screen instructions, then press **Accept** to store the sample weight (submerged in liquid).



Measure Result

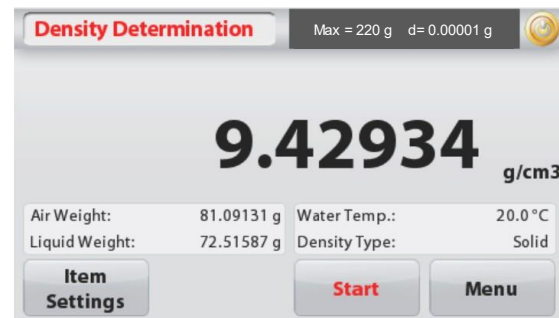

Once the necessary weights have been determined, the density of the sample is displayed in **g/cm³** (along with the weight in air, weight in water) on the Application screen.

Press **Start** to reset all the weight values and restart the process.

4.5.2 Measuring the Density of a Buoyant Material Using Water

Press the **Item Settings** button to open **Settings** screen.

Confirm the following **Setups** are selected:

- ✓ **Density Type: Solid**
- ✓ **Liquid Type: Water**
- ✓ **Porous Material: Off**
- ✓ **g/cm³: to select the display resolution of Density's weighing result.**

Press **Back** to return to the Density Determination home screen.

Follow the same procedure as Solid Material above, except in Density Determination step 2, **push the sample down** into the liquid until it is fully submerged.

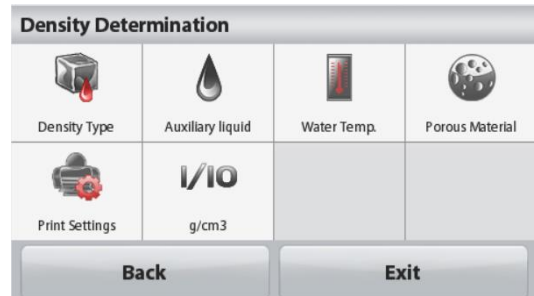

4.5.3 Measuring the Density of a Solid Using an Auxiliary Liquid

To enable this feature, enter the Density Determination Setup menu and select the following: **Density Type: Solid; Liquid Type: Other; Porous Material: Off.**

Confirm the default values displayed (Liquid Density, etc) are correct.

To adjust the Liquid Density value, touch the **Auxiliary liquid** button and select Other.

A numeric input window appears.

Key in the density in g/cm³, then press **Save**.

The display returns to the previous screen.

To return to the Density Determination home screen, touch **Back**.

Begin the Density determination process as per above.



4.5.4 Measuring the Density of a liquid using a Calibrated Sinkers (not supplied)

To enable this feature, enter the Density Setup menu and select the following; **Density Type: Liquid**.

Note: when the Density Type is set to Liquid, the Liquid type and Porous material selections are disabled.

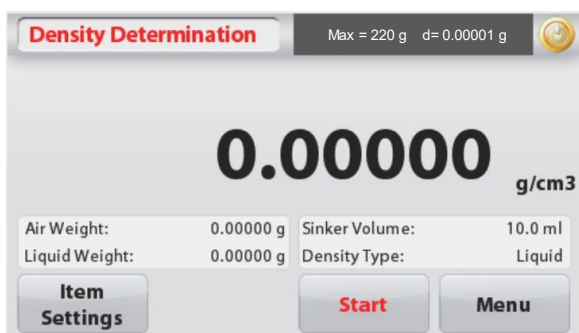

The **Density Determination – Liquid** Home screen

Main Display Line

Reference Fields

Function Buttons

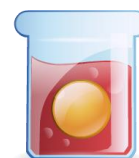

Application Icon

Confirm that the default value displayed (sinker volume) is correct. To edit the default values, touch **Sinker Volume**.

To adjust the Sinkers volume value, touch the **Sinker Volume** button.

A numeric input window is displayed.

Key in the desired value, then press **Save**.

The display returns to the previous screen with the new value highlighted.

To return to the Density Determination home screen, touch **Back**.

Press **Start** to start the process.

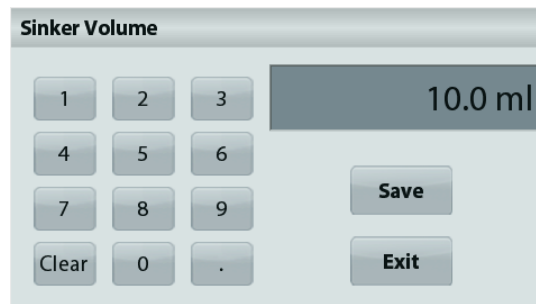

Step 1 of 2 – Weigh the Sinker in Air.

Follow the screen instructions, then press **Accept** to store the sinker weight (“in air”).

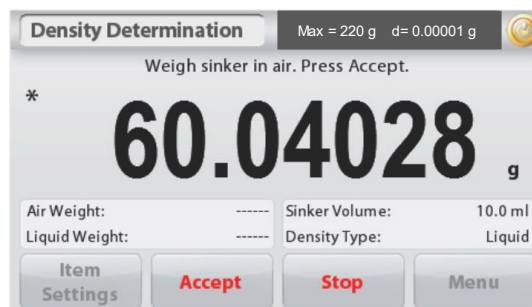
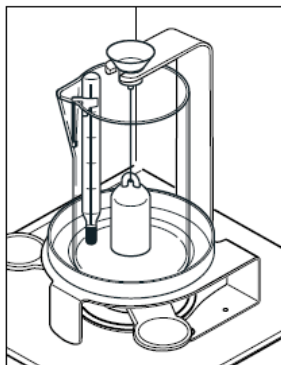
**Step 2 of 2 – Weigh the Sinker Submerged in the Test Liquid.**

Follow the screen instructions, then press **Accept** to store the sinker weight (submerged in liquid).

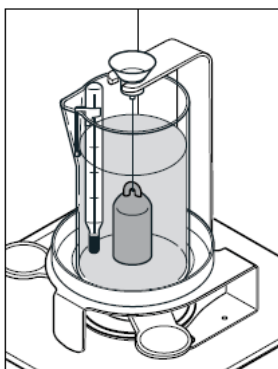

Once the necessary weights have been determined, the density of the Liquid sample is displayed in **g/cm³** (along with the weight in air, weight in water) on the Application screen.

Press **Start** to reset all the weight values and restart the process.

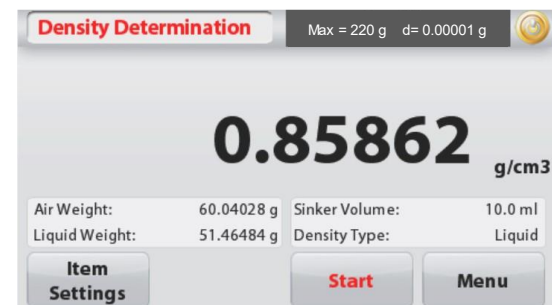
**4.5.5 Measuring the Density of Porous Material Using Oil**

To enable this feature, enter the Density Determination **Setup** menu, and set the following:

- ✓ **Density Type: Solid**
- ✓ **Liquid Type: Water**
- ✓ **Porous Material: On**
- ✓ **g/cm³: to select the display resolution of Density's weighing result.**

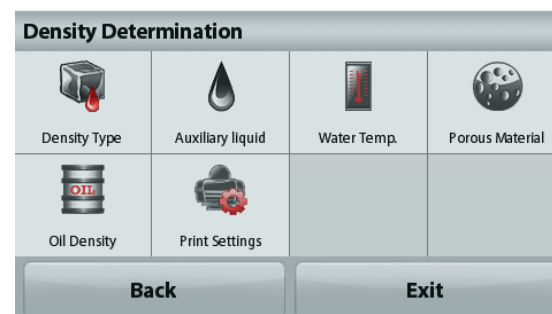



The **Density Determination – Porous** Home screen

Main Display Line

Reference Fields

Functions Icon



Application

Confirm the default values displayed (Water Temp) are correct. To edit the default values, touch **Item Settings**. The Settings screen appears.

The balance calculates water density based on the water temperature value entered (look-up table).

Measure the actual water temperature using a precision thermometer.

To adjust the Water Temperature or Oil Density values, touch the **Water Temp** or **Oil Density** button.

Numeric input windows appear.

Key in the desired value, then press **Save**.

The display returns to the previous screen with the new value highlighted.

To return to the Density Determination home screen, touch **Exit**.

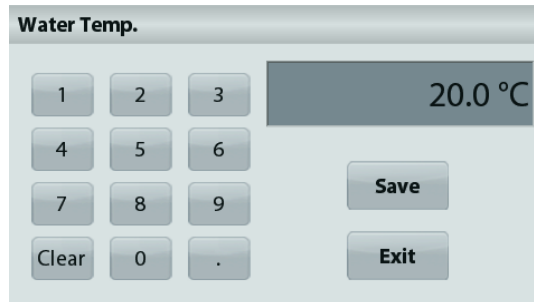
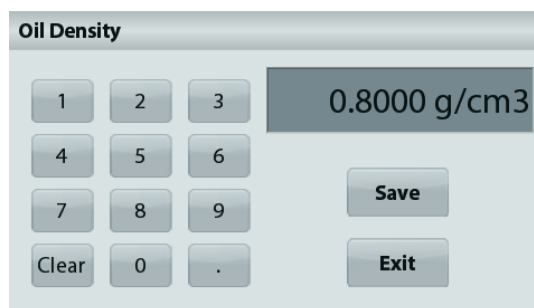

Press **Begin Density Calculation**.

Step 1 of 3 – Weigh the Un-Oiled Sample in Air.

Follow the screen instructions then press **Accept** to store the dry sample weight (in air).



Step 2 of 3 – Weigh the Oiled Sample in Air.

Follow the screen instructions then press **Accept** to store the sample weight (oiled).



Step 3 of 3 – Weigh the Oiled Sample Submerged in Liquid.

Follow the screen instructions then press **Accept** to store the oiled sample weight (submerged in liquid).



Once the necessary weights have been determined, the density of the sample is displayed in **g/cm³** (along with the weight in air, un-oiled and oiled, and weight in water) on the Application screen.

The value stays on the display until **Start** is touched.

Press **Start** to reset all the weight values and restart the process.

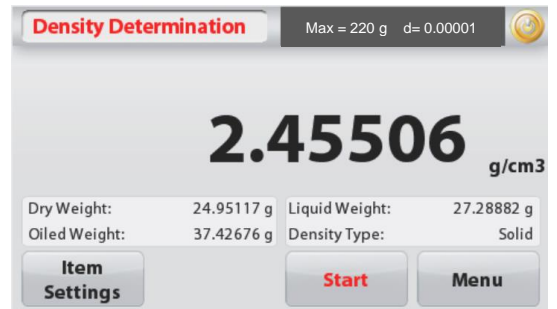

4.6 Check Weighing

Note: Before using any application, be sure the balance has been leveled and calibrated.

Check Weighing is used to compare the weight of a sample against target limits.

Check Weighing

1. In the upper left portion of the home screen, select Check Weighing
2. The default (or last) Check weight limits are displayed.
3. Place objects on the pan.
4. The Under/Accept/Over status is shown in the progress bar area while the actual weight of the item is shown on the main Display Line.



The **Check Weighing** Home screen

Main Display Line

Reference Fields

Function Buttons



Application Icon

To set the *Over Limit value*, touch the **Over Limit** button

To set the *Under Limit value*, touch the **Under Limit** button

A numeric input window appears.

Enter the desired Limit Weight, then press **Save**.

To return to the CHECK WEIGHING home screen,
touch **Exit**.

The screenshot shows a numeric input window titled "Under Limit". On the right side, a dark grey box displays the value "0.10 g". Below this box are two buttons: "Save" and "Exit". On the left side, there is a numeric keypad with buttons for digits 1 through 9, a "Clear" button, a "0" button, and a "." (decimal) button.

The screenshot shows a numeric input window titled "Over Limit". On the right side, a dark grey box displays the value "4199.99 g". Below this box are two buttons: "Save" and "Exit". On the left side, there is a numeric keypad with buttons for digits 1 through 9, a "Clear" button, a "0" button, and a "." (decimal) button.

4.6.1 Item Settings

To view or adjust the current settings

Touch the **Item Settings** button. The Settings screen appears.

Sample Name: Assign a name to the sample.

Print settings: Change printing settings. See section 7 for more information.

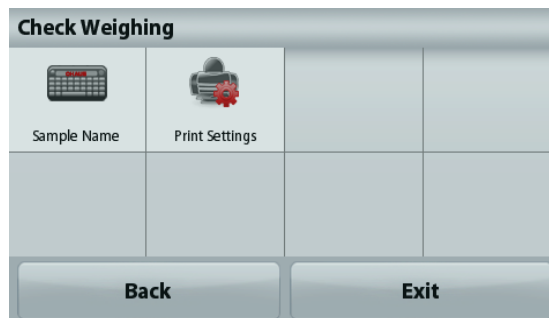

4.7 Display Hold

Note: Before using any application, be sure the balance has been leveled and calibrated.

Two Modes are available:

Display Hold - allows the user to capture and store a stable weight.

Peak Hold - allows the user to capture and store the highest stable weight.



The **Display Hold** Home screen

Main Display Line

Reference Fields

Function Buttons



Display Hold

4.7.1 Display Hold

1. In the upper left portion of the home screen, select Display Hold
2. Place the sample on the pan and press **Hold** at any time while the weight is being captured.
3. The Main Display Line now shows the first stable weight.
4. Press **Clear** to remove the hold and return to Display Hold Home screen.



Peak Hold

4.7.2 Peak Hold

1. In the upper left portion of the home screen, select Display Hold
2. Choose Peak Hold Mode in Item Settings (see section 4.7.3).
3. Place sample on the pan and press **Start** to begin.
4. Continue to weigh samples. The highest stable weight will be held.
5. To remove the hold and return to normal operation press **Stop**.



4.7.3 Item Settings

To view or adjust the current settings

Touch the **Item Settings** button. The Settings screen appears.

Mode: Choose between Peak Hold and Display Hold (default).

Sample Name: Assign a name to the sample.

Print settings: Change printing settings. See section 7 for more information.

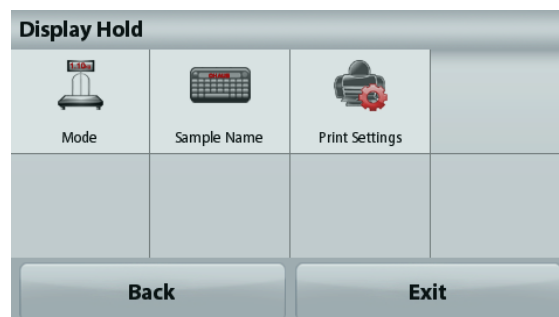

Note: The **Save to USB** button will only appear after a USB flash drive has been connected to the balance. See section 4.1.4 for more information.

4.8 Totalization

Note: Before using any application, be sure the balance has been leveled and calibrated.

Totalization measures the cumulative weight of a sequence of items. The cumulative total may exceed the capacity of the Balance. The maximum number of samples (n) is 99.



The **Totalization** Home screen

Main Display Line

Reference Fields

Application Buttons



Application Icon

Totalization

1. In the upper left portion of the home screen, select Totalization
2. Place item on the pan to begin. The sample weight is shown on the Main Display Line.
3. Press **Accumulate** to add the weight (when stable) of the item to the total.
4. Remove the item from the weighing pan, then add the next item and continue as above.
5. Press **Result** to view the results from the totalization.
6. When finished, press the Clear Total button to reset the accumulated weight to zero.

Totalization	
Item	Result
Samples	3
Total	506.95 g
Average	168.98 g
σ (stdev)	38.90 g
Minimum	117.00 g
Maximum	210.57 g
Range	93.57 g

Save to USB Exit

7. Press **Save to USB** to save the result to a USB flash drive or **Exit** to return to the Totalization Home screen.

Note: Changing units converts the Accumulation results to the selected unit.

4.9 Formulation

Note: Before using any application, be sure the balance has been leveled and calibrated.

Use this application for compounding and recipe making. The maximum number of components is 50.



The **Formulation** Home screen

Main Display Line

Reference Fields

Application Buttons



Application
Icon

Formulation

1. In the upper left portion of the home screen, select Formulation
2. Press **Start** to begin the compounding process.
3. Place the first ingredient on the pan (or in a tared container) and press **Accept** to store the component.
4. Continue adding components and pressing **Accept** to store the weight of the individual components until the formula is complete. The **Total** line shows the total weight of all the components.
5. Press **Stop** to finish the Formulation. The Formulation results are displayed:

Note: If Filler is set to On (see section 4.9.1 below), the balance will ask to add a filler material to complete the formulation. Add the filler material and press **Accept** to complete the formulation and display the results.

Formulation	
Comp.	Weight
1	241.76 g
2	272.95 g
Comp. Total	514.71 g

Save to USB Exit

6. Press **Save to USB** to save the results to a USB flash drive or **Exit** to return to the Formulation Home screen.

Note: The formulation results will be cleared when a new formulation starts.

4.9.1 Item Settings

To view or adjust the current settings

Touch the **Item Settings** button. The Settings screen appears.

at **Filler:** If set to On, a filler material is asked for the end of the formulation.

Automatic Mode: If set to On, the balance will automatically Tare after the component weight has been accepted.

Print settings: Change printing settings. See section 7 for more information.

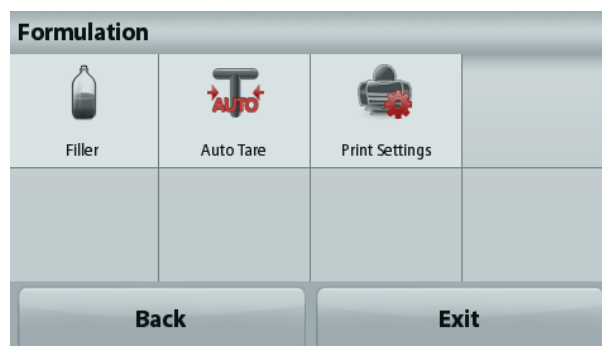

4.10 Additional Features

4.10.1 Weigh Below

The Adventurer balance is equipped with a weigh below hook for weighing below the balance.

Note: Before turning the balance over, remove the pan and draft shield elements (if present) to prevent damage



Attention: Do not place the balance on the pan support cone or Load cell Pins

To use this feature, remove power from the balance, then remove the protective cover for the weigh below opening.



Weigh below protective cover



Weigh below hook

The balance can be supported using lab jacks or any other convenient method. Ensure the balance is level and secure. Power on the balance, then use a string or wire to attach items to be weighed.

5. MENU SETTINGS

5.1 Menu Navigation

User menu structure:

Application Modes

Weighing	Counting	Percent	Dynamic	Density	Check Weighing	Display Hold	Totalization	Formulation
Min Weight	Sample Size	Recalculate Ref Wgt	Average Time	Density Type	Sample Name	Display Hold Mode		Filler
Capacity Guide	APW	Print Settings	Auto Mode	Auxiliary Liquid	Print Settings	Sample Name		Automatic Mode
Batch Printing	Auto Opt		Sample Name	Water Temp.		Print Settings		Print Settings
Units	Print Settings		Print Settings	Porous Material				
Filter Level				Oil Density				
GLP and GMP Data				Sinker Volume				
Print Settings				Liquid Temp.				
Level Assist				Print Settings				

Menu

Calibration	Balance Setup	Weighing Units	Data Maintenance	Communication	GLP and GMP Data	Factory Reset	User Management
Internal Cal	Language	Milligram	Export to USB	RS232 Standard	Headers		User Profiles
Automatic Cal	User Settings	Gram	App. Mode Settings	Baud Rate	Header 1		Change Password
AutoCal™	Touch Calibrate	Kilogram	Menu Settings	1200 / 2400 / 4800 / 9600 / 19200 / 38400	Header 2		Auto Standby
Span Cal	Brightness	Carat	Import from USB	Transmission	Header 3		
Linearity Cal	Beep	Ounce	App. Mode Settings	7E1 / 7E2 / 7N1 / 7N2 / 7O1 / 7O2 / 8N1 / 8N2	Header 4		
Cal Test	Auto Dim	OunceTroy	Menu Settings	Handshake	Header 5		
	Level Assist	Pound	Balance_Info	None	Balance Name		
	Filter Level	Pennyweight		Xon / Xoff	User Name		
	Auto Zero Tracking	Grain		hardware	Project Name		
	Auto_Tare	Newton		Print Settings			
	Graduation	Momme		Print Output			
	Date & Time	Mesghal		Stable Weight Only			
	Date	HKTael		Numeric Value Only			
	Time	SGTael		Single Header Only			
	Approved Mode	TWTael		Print Options			
		Tical		Printer / PC			
		Tola		Output format			
		Baht		OHAUS / SICS / ST			
		Custom1		Auto Print			
		Unit Name		Auto Print Off			
		Factor		On Stability			
		Exponent		Load / Load and Zero			
		10 ⁻³		Interval (seconds)			
		10 ⁻²		Continuous			
		10 ⁻¹		Print Content			
		10 ⁰		Selection, Header, Date & Time, Balance ID, Balance Name, User Name, Project Name, Application Name, Sample Name, Result, Gross, Net, Tare, Information, Signature Line, Verified Line			
		10 ¹		Feed			
		10 ²		1 line / 4 lines			
		10 ³		Print line setting			
		LSD		Single line / multiple lines			
		0.5		Print calibration data			
		1		Label printing			
		2		Save To USB			
		5					
		10					
		100					

All menu navigation is performed by touching the display. To enter the Menu, touch **Menu** from any Application Home screen. The Main menu appears, with buttons for **Back** and **Exit**. Continue touching the appropriate list item to navigate to the Menu items.

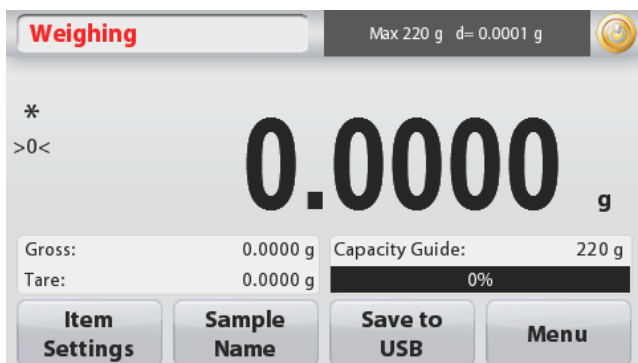

5.1.1 Changing Settings

To change a menu setting, navigate to that setting using the following steps:

Enter the Menu

From any Application screen, Touch **Menu**. The Main Menu List appears on the display.

Select the Sub-Menu

Find the item of the Main Menu List and touch it. The Sub-Menu appears.

Select the Menu Item

Continue until the desired setting is chosen in the Menu list. Touch the setting to change it. The changed setting will be displayed as highlighted yellow for about 1 second to confirm the changed value.

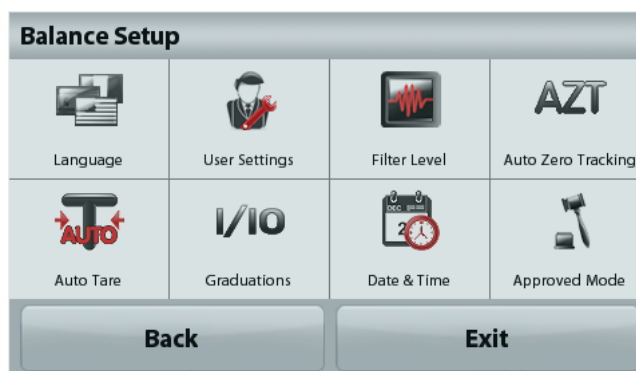

Exit the Menu and Return to the Current Application

After the setting is confirmed, touch **Exit** to return to the Application.

Note: at any time the **Back & Exit** buttons can be touched to navigate to the desired area of the menu or return to the current Application. Continue until the desired setting is chose in the menu list.

The Adventurer balance Main menu structure is illustrated below.

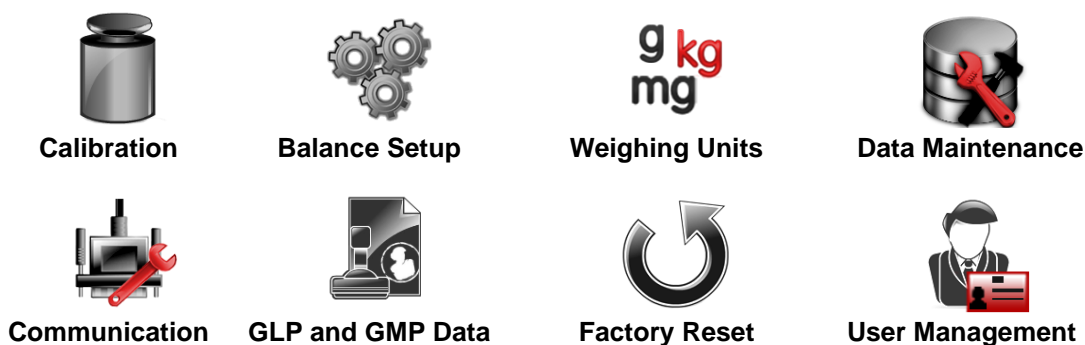

5.2 Calibration

Adventurer Balances (InCal models) offer a choice of six calibration methods: Internal Calibration, Automatic Calibration, AutoCal™ Adjustment, Span Calibration, Linearity Calibration and Cal Test (Calibration Test).

Note: The calibration unit is always in grams.

Attention: Do not disturb the balance during any calibration.

5.2.1 Calibration sub-menu (InCal models)

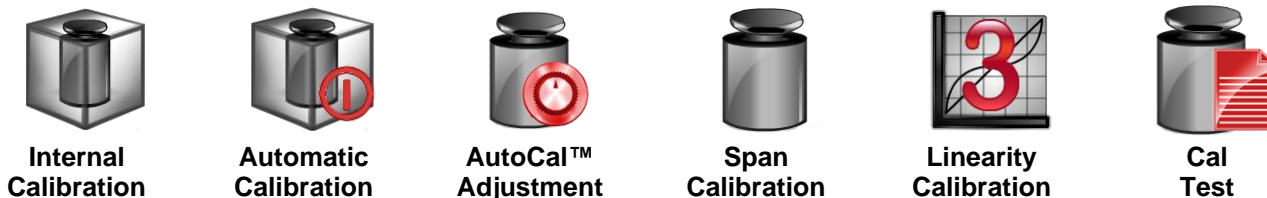

Note: /E models only have Span Calibration, Linearity Calibration and Cal Test.

5.2.2 Internal Calibration

Calibration is accomplished with the internal calibration mass. Internal Calibration can be performed at any time, provided the balance has warmed up to operating temperature and is level.

With the Balance turned ON and no load on the pan, touch **Internal Calibration**. Then touch **On** or **Off** to turn it on or off.

Note: When touch **Off**, press the **CAL** button on the control panel will start span calibration.

To start calibration, touch **Calibration** after **On** is selected.

Note: The default is **On**.

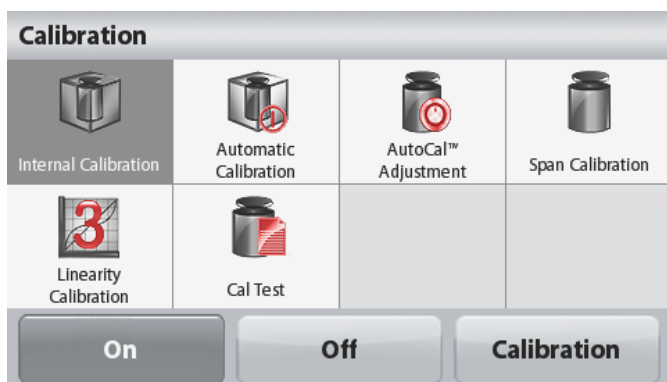

The Balance begins to calibrate. Follow the onscreen instruction to clear the pan and wait for the process to finish.

The display shows the status, and returns to the current application after the calibration is finished.

To cancel at any time, press **Save**.

5.2.3 Automatic Calibration

When **Automatic Calibration** is set ON, the balance performs a self-calibration:

- when it senses a temperature change of 1.5°C
- or every 11 hours

AutoCal will automatically calibrate the Balance (using the internal mass) each time there is a change in temperature significant enough to affect accuracy or every 11 hours.

An information screen will appear when an Automatic Calibration is about to start. Three option buttons will be displayed:

- Now** – Press to perform the calibration directly.
- 5 min** – Press to perform the calibration after 5 minutes.
- Deactivate** – Press to deactivate the Automatic Calibration function.

5.2.4 AutoCal™ Adjustment

Use this calibration method to adjust the span calibration point, without affecting the span or linearity calibration.

Calibration Adjust may be used to adjust the result of the Internal Calibration by ± 100 divisions.

Note: Before making a calibration adjustment, perform an Internal Calibration. To verify whether an adjustment is needed, place a test mass equal to the **span calibration value** on the pan and note the difference (in divisions) between the nominal mass value and the actual Balance reading. If the difference is within ± 1 division, calibration adjustment is not required. If the difference exceeds ± 1 division, calibration adjustment is recommended.

Example:

Actual weight reading:	200.014
Expected weight reading:	200.000 (Test mass value)
Difference Weight (d):	0.014
Difference weight in digits:	-14 (Adjust value)

To perform a Calibration Adjustment, touch AutoCal Adjustment from the Calibration Menu; Enter the value (positive or negative divisions) to match the difference noted earlier in the procedure.

Recalibrate using Internal Calibration. After calibration, place the test mass on the pan and verify that the mass value now matches the displayed value. If not, repeat the procedure until Internal Calibration reading agrees with the test mass.

Once completed, the balance stores the Adjustment value and the display returns to the current application.

5.2.5 Span Calibration

Span calibration uses two calibration points, one at **zero load** and the other at **specified full load** (span). For detailed calibration mass information please see the specification tables in section 9.

With the balance turned ON and no load on the pan, touch Span Calibration to initiate the procedure. Additional calibration values to be used are shown on the display. The best accuracy is achieved using the mass closest to the full span value.

Note: To change the span calibration point, touch the alternate weight shown on the display. Follow the screen instructions and place the specified calibration weight on the scale when prompted to do so. When complete, the display shows the Span calibration status and returns to the current application.

5.2.6 Linearity Calibration

Linearity calibration uses three calibration points, one at zero load and the others at specified loads.

With no load on the scale, press Linearity Calibration to begin the process.

The balance captures the zero point, and then prompts for the next weight.

Continue to follow the instructions on the display until the calibration is completed.

To cancel at any time, press **Cancel**.

5.2.7 Calibration Test

Use Calibration Test to compare a known calibration weight against the stored span calibration data.

With no load on the scale, press **Cal Test** to begin the process.

The balance captures the zero point, then prompts for the span value.

The display shows status, followed by the difference between the current calibration weight and the stored calibration data.

5.3 Balance Setup

Enter this sub-menu to customize Balance functionality.

5.3.1 Balance Set-up sub-menu



Language



User Settings



Filter Level

AZT

Auto Zero Tracking



Auto Tare

I/O

Graduations



Date & Time



Approved Mode

Factory default settings are shown below in bold.



5.3.2 Language

Set the language displayed for menus and displayed messages.

English
German
French
Spanish
Italian
Polish
Turkish
Czech
Hungarian



5.3.3 User Setting

Use this sub-menu to change the setting for:

Touch Calibrate

“Runtime calibration, please touch the screen at the center of the ring”
(First top-left, then bottom-right.)

Screen Brightness:

LOW = low screen brightness.

MEDIUM = normal screen brightness.

HIGH = high screen brightness.

Beep:

OFF = disabled

ON = enabled

Auto Dim (Dims the display if no Screen Activity for x minutes)

OFF = disabled

10 min

20 min

30 min

Auto Off:

After auto off, you need to manually press the mechanical power button on the control panel to turn on the balance.

Off = **Disabled**

30 minutes = Power off if there is no motion on the screen for 30 minutes

1 hour = Power off if there is no motion on the screen for 1 hour

2 hours = Power off if there is no motion on the screen for 2 hours

Level Assist: Instructions on how to move the balance feet to level the balance.



5.3.4 Filter Level

Set the amount of signal filtering.

- LOW = faster stabilization time with less stability.
- MEDIUM** = normal stabilization time with normal stability.
- HIGH = slower stabilization time with more stability.



5.3.5 Auto Zero Tracking

Set the automatic zero tracking functionality.

- OFF = disabled.
- 0.5 D** = display maintains zero up to a drift of 0.5 graduation per second
- 1 D = display maintains zero up to a drift of 1 graduation per second.
- 3 D = display maintains zero up to a drift of 3 graduations per second.



5.3.6 Auto Tare

Set the automatic Tare.

- OFF = disabled.
- ON = enabled.

'Place container on the pan' will be displayed when an Automatic Tare is about to start.

A **Deactivate** button is displayed underneath the text. Press this button to deactivate the Automatic Tare function

5.3.7 Graduations

Set the displayed readability of the balance.

- 1 Division** = standard readability.
- 10 Divisions = readability is decreased by a factor of 10.



For example, if the standard readability is 0.01g, selecting 10 Divisions will result in a displayed reading of 0.1g.



5.3.8 Date & Time

Set the current Date and Time.

Change the format (if desired), then enter the current value.

Press **Save** to confirm the new value.

Date Setup

Click the number corresponding to the year, month, or day, and short press the **Clear** button to clear it. Enter the correct value and click **Save**.

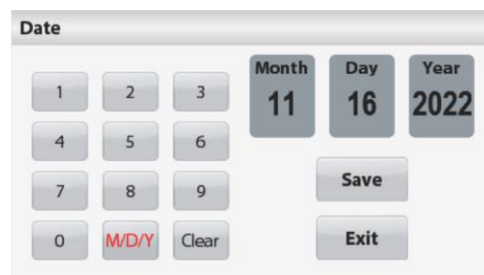

Time Setup

Click the number corresponding to the hour and minute, and short press the **Clear** button to clear it. Enter the correct value and click **Save**.

Note: The value corresponding to the second cannot be set manually.

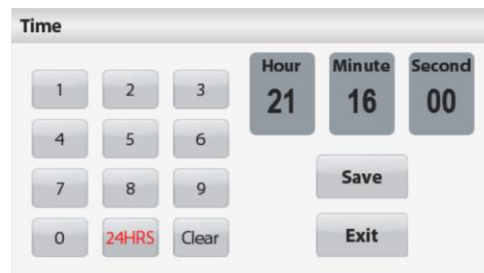



5.3.9 Approved Mode

Use this menu to set the Legal for Trade status.

OFF = standard operation.

ON = operation complies with Legal Metrology regulations.

Note: When Approved Mode is set to ON, the menu settings are affected as follows:

Calibration Menu:

Automatic Calibration is forced to be turned ON and hidden. Internal Calibration and Calibration Test functions are available. All other functions are hidden.

For AX...N... models:

- Automatic Calibration will be locked at its current setting.
- If you set Internal Calibration to be On before you turn on Approved Mode, Internal Calibration menu will still be available.
- If you set Internal Calibration to be Off before you turn on Approved Mode, Internal Calibration menu will be locked.

Balance Setup Menu:

Filter Level is locked at the current setting.

Auto Zero Tracking is limited to 0.5 Division and OFF. The selected setting is locked.

Auto Tare is locked at current setting.

Graduations is forced to 1 Division and the menu item is hidden.

For AX...N... models, graduations will be locked at its current setting.

Communication Menu (Communication->Print Settings->Print Output):

Stable Weight Only is locked ON.

Numeric Value Only is locked OFF.

Communication Menu (Communication->Print Settings->Auto Print):

For AX...N...models, auto print mode selections are limited to OFF, On Stability, and Interval. Continuous is not available.

Data Maintenance Menu:

Export to USB is hidden

Import from USB is hidden

Lockout Menu:

Menu is hidden

Note: The security switch located at the rear of the balance must be in the locked position to set Approved Mode to ON. The security switch must be in the unlocked position to set Approved Mode to OFF. See Section 6.

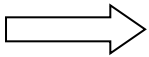



















Weighing application main screen with LFT turned ON.

5.4 Weighing Units

Enter this sub-menu to activate the desired units of measure. This menu can also be accessed by pressing the unit symbol in an application home screen.

Note: Due to national laws, the balance may not include some of the units of measure listed.

5.4.1 Units Sub-menu

 Milligram	 gram	 Kilogram	 carat	 ounce	 ounce troy
 Pound	 pennyweight	 Grain	 Newton	 momme	 mesghal
 Tael (HK)	 Tael (SG)	 Tael (TW)	 tical	 tola	 baht
 Custom Unit 1					

Note: If Approved Mode is set to **ON**, some units will not be displayed.

Use the Custom Unit to display weight in an alternative unit of measure. The custom unit is defined using a conversion factor, where the conversion factor is the number of custom units per gram expressed in scientific notation (Factor x 10^{Exponent}).

For example: To display weight in troy ounces (0.03215075 troy ounces per gram) enter a Factor of 0.3215075 and an Exponent of -1.

The Custom Unit's name can be customized up to 3 characters.

5.5 Data Maintenance

Enter this sub-menu to customize data transfer settings.

5.5.1 Data Maintenance sub-menu

The Export and Import functions

Setting up multiple balances is simple by exporting the profile from a master balance via a USB drive. The data maintenance tool allows you to save user and application settings to a USB, which can be easily transferred to other Adventurer balances. The data can then be used to configure additional Adventurer balances with the data imported from original balance.



5.5.2 Export to USB

Export weighing data to a USB flash drive. Two types of data can be exported:

- Application settings (APW, Ref. weight and etc.)
- Menu settings (balance setup function and etc.)

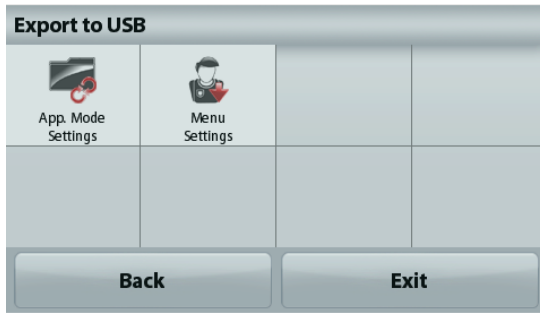

Note: The function Save to USB needs to be set to ON to enable data transfer to USB. Please see section 5.6 for more information.



5.5.3 Import from USB

Import weighing data from a USB flash drive.



5.5.4 Balance Info

Enter to view information about the balance. Information displayed includes: Balance Type, Balance ID, Capacity, Readability and Software Version.

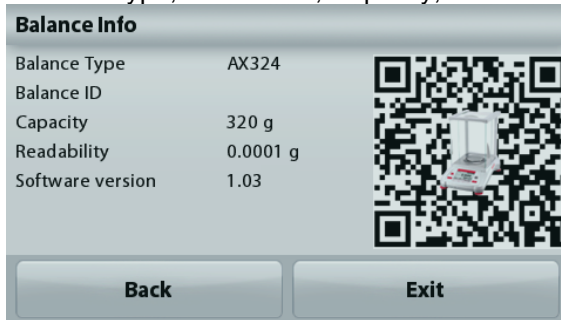

5.6 Communication

Enter this menu to define external communication methods and to set printing parameters. Data may be output to either a printer or PC.

Factory default settings are shown in bold. Enter to view information about the balance.

Communication Sub-menu



RS-232 Standard



Print Settings



Save to USB

5.6.1 RS-232 Standard:

Enter this sub-menu to customize RS-232 Standard settings.

5.6.1.1 Baud Rate

Set the baud rate (bits per second).

- 1200 = 1200 bps
- 2400 = 2400 bps
- 4800 = 4800 bps
- 9600** = 9600 bps
- 19200 = 19200 bps
- 38400 = 38400 bps



5.6.1.2 Transmission

Set the data bits, stop bit, and parity.

- 7 EVEN 1 = 7 data bits, even parity, stop bit 1
- 7 ODD 1 = 7 data bits, odd parity, stop bit 1
- 7 EVEN 2 = 7 data bits, even parity, stop bit 2



7 ODD 2	= 7 data bits, odd parity, stop bit 2
7 NONE 1	= 7 data bits, no parity, stop bit 1
8 NONE 1	= 8 data bits, no parity, stop bit 1
7 NONE 2	= 7 data bits, no parity, stop bit 2
8 NONE 2	= 8 data bits, no parity, stop bit 2



5.6.1.3 Handshake

Set the flow control method.

NONE	= no handshaking
XON-XOFF	= XON/XOFF handshaking
HARDWARE	= hardware handshaking

5.6.2 Print Settings

Enter this sub-menu to customize data transfer settings.

Print Settings sub-menu



Print Output



Auto Print



Print Content



Feed



Format



Print Calibration Data



Label Printing

5.6.2.1 Print Output



Stable Weight Only

Set the printing criteria.

OFF	= values are printed immediately, regardless of stability.
ON	= values are printed only when the stability criteria are met.

Numeric Value Only

Set the printing criteria.

OFF	= All Result and G/N/T data values are printed. See section 7.2 for more information
ON	= Only numeric data values are printed

Single Header Only

Set the printing criteria.

OFF	= Headers will be printed for every print requirement
ON	= Headers will be printed once a day

Print Options

Set the printing criteria.

Printer	= Print data to a printer
PC	= Print data to a PC

Output Format

Select a print format:

OHAUS	=OHAUS Format
SICS	=Mettler Toledo Format
ST	=Sartorius Format

5.6.2.2 Auto Print

Set the automatic printing functionality.

OFF	= disabled
ON STABILITY¹	= printing occurs each time the stability criteria are met.
INTERVAL²	= printing occurs at the defined time interval.
CONTINUOUS	= printing occurs continuously.

¹When ON STABILITY is selected, set the conditions for printing.

LOAD	= Prints when the displayed load is stable.
LOAD ZERO	= Prints when the displayed load and zero reading is stable.



²When INTERVAL is selected, set the time interval using the numeric keypad.
Settings of 1 to 3600 seconds are available. Default is 0.



5.6.2.3 Print Content

Define the content of the printed data.

Selection

Set the status.

Deselect All = all are set to OFF

Select All = all are set to ON

Header

Date & Time

Balance ID

Balance Name

User Name

Project Name

Application Name

Sample Name

Result

Gross

Net

Tare

Information

Signature Line

Verified line



5.6.2.4 Feed

Set the paper feed.

1 LINE = move the paper up one line after printing.

4 LINE = move the paper up four lines after printing.



5.6.2.5 Format

Set the printing format.

Single Line = prints on a single line.

Multiple Lines = prints on multiple lines.



5.6.2.6 Print Calibration Data

Set the printing criteria.

Off = Turn off the print calibration data function

On = Turn on the print calibration data function



5.6.2.7 Label Printing

OFF = Turn off the label print

ON = Turn on the label print

There is a built-in English label template:

A label template based on a label size of 100 mm x 75 mm. The template includes all basic information such as the "date/time", "balance name", "balance ID", "sample name", "gross weight", "tare weight", "net weight", and "signature column".

You can use the OHAUS Label Designer software to edit the label template. Please download the software via the following link.

<https://dmx.ohaus.com/WorkArea/DownloadAsset.aspx?id=28916>

Please contact an authorized dealer to obtain the software manual. Refer to the software instructions for details on how to set up the Label Designer.

5.6.3 Save to USB

Set the status.

OFF = the data will not be saved to USB

ON = the data will be saved to USB

5.7 GLP and GMP Data

Enter this menu to set the Good Laboratory Practices (GLP) data and the Good Manufacturing Practices data.

5.7.1 GLP Data Sub-menu



Header



Balance Name



User Name



Project Name

5.7.2 Header



Enables the printing of GLP headings. There are up to 5 headings available.

Alphanumeric settings up to 25 characters are available for each Header setting.

5.7.3 Balance Name



Set the balance identification.

Alphanumeric settings up to 25 characters are available. The default setting is **Adventurer**.

5.7.4 User Name



Set the user identification.

Alphanumeric settings up to 25 characters are available. The default setting is **blank**.

5.7.5 Project Name



Enter this menu to set the Project identification.

Alphanumeric settings up to 25 characters are available. The default setting is **blank**.

5.8 Factory Reset

Use this sub-menu to reset the all menu settings to their Factory default settings.

Note: Calibration data is not affected.

- Reset All = resets all menus to their factory default settings.
- Exit = return to application main screen without resetting any menus.

5.9 User Management

For the grouping of users, you can set up to 10 ordinary users, 2 supervisors, and 1 administrator (by default). The authority level for each role can be identified by viewing the user management preset authority table.

The administrator can create, edit, or delete supervisors and ordinary users. The supervisors can create, edit, or delete ordinary users. Ordinary users cannot access user data or the automatic hibernation menu.

After entering User Management, you can set three sub-menus: **User Profiles**, **Change Password**, and **Auto Standby**.

5.9.1 User Profiles



You can create a new user, edit the authority of the user, or delete the user.

- To create a new user: Short press the **Create** button, enter the user's name, and then short press the **Save** button to confirm.
- To edit the user authority: Select the target user name, and short press the **Edit** button.

You can click the field corresponding to the user name, password, and user group to edit the user name, password, and user group.

Note:

1. The password shall contain 6-10 characters, but special characters such as %, &, \$, #, @, /, +, *, and () are not allowed.
 2. You can edit the password of an existing user through the following path:
User Management > Password Modification.
- To delete a user: Select the target user name and click the **Delete** button.

Select the **YES** button to successfully delete the user.

User Profiles			
#	User Name	Group	Password
>> 1	Admin	Administrator	
2	1	Operator	
3	2	Operator	
4	3	Operator	
5	4	Operator	

New Edit Delete Back

User

User Name 1

Password *****

Group Operator

Back

Enter Password

1 2 3 4 5 6 7 8 9 0

q w e r t y u i o p

a s d f g h j k l ↵

↑ z x c v b n m . ←

Save Back

User Profiles			
#	User Name	Group	Password
>> 1	Admin	Administrator	
2	1	Operator	*****
3	2	Operator	
4	3	Operator	
5	4	Operator	

New Edit Delete Back

User Manager

Are you sure you want to delete the selected user?

No Yes

User Management Preset Authority Table

Setup and Program	Administrator	Supervisor	Ordinary User
Create/delete an account	√	√ (Only edit ordinary users)	X
Edit an account	√	X	X
User data	√	√	X
Edit a user's name	√	√	X
Modify the password	√	√	X (is allowed to modify his/her own password)
Automatic standby	√	√	X
Language	√	√	√
Balance settings	√	√	X
Date and time	√	X	X
Calibration setup	√	√	X (Based on the settings of the administration)
Internal calibration	√	√ (Based on the settings by the administration)	When the administrator sets it to Off, other users cannot access it.
External calibration	√	√	√
Linear calibration	√	√	X
Other calibrations setup	√	√	X
Basic weighing mode	√	√	√
Minimum weighing value	√	√	X
Capacity bar, quantity of samples, average piece weight of samples (piece weighing), density settings, etc.	√	√	√
GLP/GMP data settings	√	√	X
Communication Settings	√	√	X
Print settings	√	√	X
Data maintenance	√	√	X
USB input/output data	√	√	X
Balance information	√	√	√
Factory reset	√	X	X
Balance name	√	√	X
Balance settings	√	√	X
Weighing unit	√	√	X



5.9.2 Change Password

With this function, you can modify the password of the current user. After entering the User Management sub-menu, click **Password Modification**, enter the old password first, then enter the new password, and click Save.

5.9.3 Auto Standby

The balance automatically enters the auto standby mode if the display screen of the balance has no dynamic display within x minutes.

Default = OFF (turn off), the time range is 1 to 240 minutes.

Note: The current user will be automatically logged out after the balance enters the auto standby mode. Users need to log in again to use the balance.



6. LEGAL FOR TRADE (LFT)

When the balance is used in trade or a legally controlled application it must be set up, verified and sealed in accordance with local weights and measures regulations. It is the responsibility of the purchaser to ensure that all pertinent legal requirements are met. As the requirements vary by jurisdiction, the purchaser is advised to contact their local weights and measures office for instructions about putting the balance into service.

*For AX...N...type models, please refer to Adventurer Balances Quick Start Guide.

6.1 Settings

Before verification and sealing, perform the following steps in order:

1. Verify that the menu settings meet the local weights and measures regulations.
2. Verify the units turned **On** are permitted by the local weights and measures regulations.
3. Perform a calibration as explained in Section 5.
4. Set the position of the Security Switch to the locked position.
5. Set Approved Mode to ON in the Balance Setup menu.

Note: When Approved Mode is set to ON, external calibration cannot be performed.

When Internal Calibration is turned off, internal calibration cannot be performed.

6.2 Verification

A weights and measures official or authorized service agent must perform the verification procedure.

6.3 Sealing

After the Balance has been verified, it must be sealed to prevent undetected access to the legally controlled settings. Before sealing the device, ensure that the security switch is in the Locked position and the Approved Mode setting in the Balance Setup menu has been set to ON.

If using a paper seal, place the seal over the security switch and Bottom Housing as shown.

If using a wire seal, pass the sealing wire through the holes in the security switch and Bottom Housing as shown.

Un-Locked



Locked with Paper Seal



Locked with Wire Seal



7. PRINTING

7.1 Connecting, Configuring and Testing the Printer/Computer Interface

Use the built-in RS-232 Port to connect either to a computer or a printer. If connecting to a computer, use HyperTerminal or similar software like SPDC described below.

(Find HyperTerminal under **Accessories/Communications** in Windows XP.)

Connect to the computer with a standard (straight-through) serial cable.

Choose **New Connection**, “connect using” COM1 (or available COM port).

Select **Baud=9600; Parity=8 None; Stop=1; Handshaking=None**. Click **OK**.

Choose Properties/Settings, then ASCII Setup. Check boxes as illustrated:

(**S**end line ends...; **E**cho typed characters...; **W**rap lines...)

Use RS232 Interface Commands (Section 9.6.1) to control the balance from a PC.

Note: When the HyperTerminal configuration is complete, it will automatically print the results of a **Cal Test** operation, and echo print commands sent to the scale.

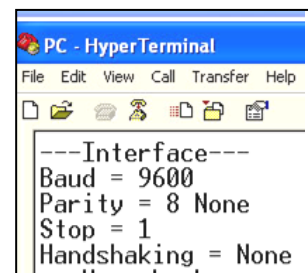

SPDC Software

The Serial Port Data Collection or SPDC software is provided by Ohaus and can be used on operating systems that do not have the HyperTerminal software mentioned above.

Choose the export file type and export file path and then press Run as shown below.

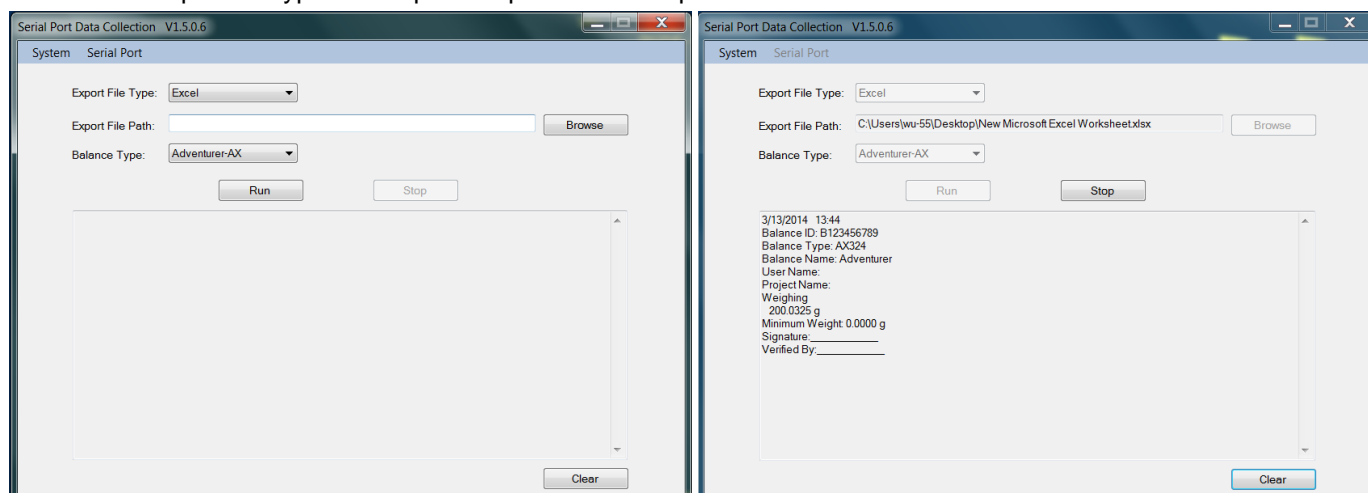

Note: The SPDC software only supports English language.

7.2 Output Format

The Result Data, and G/N/T data, is output in the following format.

Field:	Label ¹	Space ²	Weight ³	Space ²	Unit ⁴	Space	Stability ⁵	Space	G/N ⁶	Space	Term. Characters ⁷
Length:		1	11	1	5	1	≤ 1	≤ 1	≤ 3	0	≤ 8

1. The length of the label field is not fixed.
2. Each field is followed by a single delimiting space (ASCII 32).
3. The Weight field is 11 right justified characters. If the value is negative, the “-“ character is located at the immediate left of the most significant digit.
4. The Unit field contains the unit of measure abbreviation up to 5 characters, right justified.
5. The Stability field contains the “?” character if the weight reading is not stable or below min-weight. The Stability field and the following Space field are omitted if the weight reading is stable.
6. The G/N field contains the net or gross indication. For net weights, the field contains “NET”. For gross weights, the field contains nothing, “G”.
7. The Termination Characters field contains CRLF, Four CRLF or Form Feed (ASCII 12), depending on the LINE FEED menu setting.

7.3 Printout Examples

Weighing
 Header 1
 Header 2
 Header 3
 Header 4
 Header 5
 1/15/2014 13:16
 Balance ID: B234567890
 Balance Type: AX224N
 Balance Name: Adventurer
 User Name: ohaus
 Project Name: ax
 Weighing
 Sample Name: apple
 1.3651 g NET
 Gross: 3.9199 g G
 Net: 1.3651 g NET
 Tare: 2.5548 g T
 Minimum Weight: 0.0000 g
 Signature: _____
Verified By: _____

Parts Counting
 Header 1
 Header 2
 Header 3
 Header 4
 Header 5
 1/15/2014 13:19
 Balance ID: B234567890
 Balance Type: AX224N
 Balance Name: Adventurer
 User Name: ohaus
 Project Name: ax
 Parts Counting
 Sample Name: apple
 Quantity: 4 PCS NET
 Gross: 94.3343 g G
 Net: 91.7795 g NET
 Tare: 2.5548 g T
 APW: 23.09999 g
 Sample Size: 23 PCS
 Signature: _____
Verified By: _____

Percent Weighing
 Header 1
 Header 2
 Header 3
 Header 4
 Header 5
 1/15/2014 13:19
 Balance ID: B234567890
 Balance Type: AX224N
 Balance Name: Adventurer
 User Name: ohaus
 Project Name: ax
 Percent Weighing
 Sample Name: apple
 Percentage: 91.7795 % NET
 Gross: 94.3342 g G
 Net: 91.7795 g NET
 Tare: 2.5548 g T
 Reference Weight: 100.0000 g
 Signature: _____
Verified By: _____

Dynamic Weighing
 Header 1
 Header 2
 Header 3
 Header 4
 Header 5
 1/15/2014 13:22
 Balance ID: B234567890
 Balance Type: AX224N
 Balance Name: Adventurer
 User Name: ohaus
 Project Name: ax
 Dynamic Weighing
 Sample Name: cat
 Final wt.: 90.4146 g
 Gross: 94.3362 g G
 Net: 90.4144 g NET
 Tare: 3.9218 g T
 Averaging Time: 5 s
 Signature: _____
Verified By: _____

Density
 Type==Solid
 Auxiliary liquid==water
 Porous material==off
 Header 1
 Header 2
 Header 3
 Header 4
 Header 5
 1/15/2014 13:31
 Balance ID: B234567890
 Balance Type: AX224N
 Balance Name: Adventurer
 User Name: ohaus
 Project Name: ax
 Density Determination
 Density Determination: 34.1592 g/cm3
 Gross: 97.1644 g G
 Net: 93.2426 g NET
 Tare: 3.9218 g T
 Weight in air: 96.0491 g
 Weight in liquid: 93.2426 g
 Auxiliary liquid: Water
 Liquid Density: 0.9982 g/cm3
 Water Temp.: 20.0 °C
 Porous Material: Off
 Signature: _____
Verified By: _____

Density
 Type==Solid
 Auxiliary liquid==water
 Porous material==on
 Header 1
 Header 2
 Header 3
 Header 4
 Header 5
 1/15/2014 13:37
 Balance ID: B234567890
 Balance Type: AX224N
 Balance Name: Adventurer
 User Name: ohaus
 Project Name: ax
 Density Determination
 Density Determination: 13.6849 g/cm3
 Gross: 95.7991 g G
 Net: 91.8773 g NET
 Tare: 3.9218 g T
 Oiled Weight: 98.8827 g
 Weight in liquid: 91.8773 g
 Auxiliary liquid: Water
 Liquid Density: 0.9982 g/cm3
 Water Temp.: 20.0 °C
 Porous Material: On
 Oil Density: 0.8000 g/cm3
 Dry Weight: 96.0490 g
 Signature: _____
Verified By: _____

Density
 Type==Solid
 Auxiliary liquid==other
 Porous material==on

Header 1
 Header 2
 Header 3
 Header 4
 Header 5
 1/15/2014 13:50
 Balance ID: B234567890
 Balance Type: AX224N
 Balance Name: Adventurer
 User Name: ohaus
 Project Name: ax
 Density Determination
 Density Determination:
 4.7794 g/cm3
 Gross: 93.2556 g G
 Net: 89.3338 g NET
 Tare: 3.9218 g T
 Oiled Weight: 110.5639 g
 Weight in liquid: 89.3338 g
 Auxiliary liquid: Other
 Liquid Density: 1.0000
 g/cm3
 Porous Material: On
 Oil Density: 0.8000 g/cm3
 Dry Weight: 101.7253 g
 Signature: _____
 Verified By: _____

Density
 Type==liquid
 Sinkers volume==10ml
 Liquid temp==26°C

Header 1
 Header 2
 Header 3
 Header 4
 Header 5
 1/15/2014 13:56
 Balance ID: B234567890
 Balance Type: AX224N
 Balance Name: Adventurer
 User Name: ohaus
 Project Name: ax
 Density Determination
 Density Determination: 0.7171
 g/cm3
 Gross: 97.5185 g G
 Net: 93.5967 g NET
 Tare: 3.9218 g T
 Sinkers weight in air: 100.7676 g
 Sinkers weight in liquid: 93.5963 g
 Sinkers Volume: 10.0 ml
 Liquid Temp.: 26.0 °C
 Signature: _____
 Verified By: _____

Check Weighing
 Type==liquid
 Sinkers volume==10ml
 Liquid temp==26°C

Header 1
 Header 2
 Header 3
 Header 4
 Header 5
 1/15/2014 13:57
 Balance ID: B234567890
 Balance Type: AX224N
 Balance Name: Adventurer
 User Name: ohaus
 Project Name: ax
 Check Weighing
 Sample Name: apple
 93.5966 g NET
 Result: Accept
 Gross: 97.5184 g G
 Net: 93.5966 g NET
 Tare: 3.9218 g T
 Over Limit: 4199.9900 g
 Under Limit: 0.1000 g
 Signature: _____
 Verified By: _____
 Signature: _____
 Verified By: _____

Display Hold

Header 1
 Header 2
 Header 3
 Header 4
 Header 5
 1/15/2014 13:59
 Balance ID: B234567890
 Balance Type: AX224N
 Balance Name: Adventurer
 User Name: ohaus
 Project Name: ax
 Display Hold
 Sample Name: apple
 Hold Weight: 93.5968 g
 Gross: 97.5185 g G
 Net: 93.5967 g NET
 Tare: 3.9218 g T
 Mode: Display Hold
 Signature: _____
 Verified By: _____

Totalization	Formulation
Header 1	Header 1
Header 2	Header 2
Header 3	Header 3
Header 4	Header 4
Header 5	Header 5
1/15/2014 14:11	1/15/2014 14:22
Balance ID: B234567890	Balance ID: B234567890
Balance Type: AX224N	Balance Type: AX224N
Balance Name: Adventurer	Balance Name: Adventurer
User Name: ohaus	User Name: ohaus
Project Name: ax	Project Name: ax
Totalization	Formulation
Total: 734.6187 g Net	Comp. Total: 11.4528 g
Gross: 93.2557 g G	Filler: 2.8063 g
Net: 89.3339 g NET	Total: 14.2590 g
Tare: 3.9218 g T	Gross: 18.1806 g ? G
Samples: 8	Net: 2.8063 g ? NET
Average: 91.8273 g	Tare: 15.3742 g T
Standard Deviation: 1.9790 g	
Minimum: 89.3339 g	-----Sample Data (g)-----
Maximum: 93.5965 g	Item 1: 1.7529 g
Range: 4.2626 g	Item 2: 2.5569 g
	Item 3: 1.3553 g
-----Sample Data (g)-----	Item 4: 1.3070 g
1 93.5964	Item 5: 1.6743 g
2 93.5964	Item 6: 2.8062 g
3 93.5964	
4 93.5965	Signature: _____
5 92.2312	Verified By: _____
6 89.3340	
7 89.3339	
8 89.3339	
Signature: _____	
Verified By: _____	

8. MAINTENANCE

8.1 Calibration

Periodically verify calibration by placing an accurate weight on the balance and viewing the result. If calibration is required, refer to section 5.2 for instructions.

8.2 Cleaning



WARNING: Electric Shock Hazard. Disconnect the equipment from the power supply before cleaning. Make sure that no liquid enters the interior of the balance.



Attention: Do not use solvents, harsh chemicals, ammonia or abrasive cleaning agents.

The housing may be cleaned with a cloth dampened with a mild detergent if necessary.

Removing and reinstalling the glass doors for cleaning:

Step 1.

On the back of the balance, press the pin and slide out the door.



Step 2.

After cleaning, slide the doors into the slot while pressing the pin mentioned in step 1.



Step 3.

Slide the doors into the slot until the back stopper aligns with the other door.



8.3 Troubleshooting

TABLE 8-1. TROUBLESHOOTING

Symptom / Display	Possible Cause	Remedy
Balance will not turn on	No power to Balance	Verify connection and voltage
Poor accuracy	Improper calibration Unstable environment	Perform calibration Move balance to suitable location
Cannot calibrate	Calibration Menu locked Approved Mode set to on Unstable environment Incorrect calibration masses	Turn Calibration menu lock off Turn Approved Mode off Move balance to suitable location Use correct calibration masses
Cannot change menu settings	Sub-menu locked Approved Mode set to on	Unlock sub-menu Turn Approved Mode off
Low Reference weight	Reference weight too small The weight on the pan is too small to define a valid reference weight.	Increase sample size
Invalid Piece Weight	Average piece weight is too small	Increase average piece weight
Operation Timeout	Weight reading is not stable	Move balance to suitable location
-----	Busy (tare, zero, printing, waiting for a stable weight)	Wait until completion

8.4 Service Information

If the troubleshooting section does not resolve your problem, contact an Authorized Ohaus Service Agent. Please visit our website www.ohaus.com to locate the Ohaus office nearest you. An Ohaus Product Service Specialist will be available to assist you.

9. TECHNICAL DATA

9.1 Specifications

Equipment Ratings

- Indoor use only
- Altitude: Up to 2000 m
- Operating temperature range: 5°C to 40°C
- Humidity: maximum relative humidity 80 % for temperatures up to 31°C decreasing linearly to 50% relative humidity at 40°C
- Mains supply voltage fluctuations: up to $\pm 10\%$ of the nominal voltage
- Electrical supply: 12VDC, 0.84A. (For use with certified or approved power supply, which must have a SELV and limited energy circuit output.)
- Overvoltage category (Installation category): II
- Pollution degree: 2

Materials

- Bottom Housing; die-cast Aluminum, Painted
- Top Housing: Plastic (ABS)
- Weighing Platforms: 18/10 stainless steel
- Draft Shield: Glass, plastic (ABS)
- Feet: Plastic (ABS)

TABLE 9-1. SPECIFICATIONS (continued)

InCal Model	AX85	AX125D	AX225D
Maximum Capacity (g) (Fine range/Full range)	82	82/120	102/220
Readability d, Fine Range (mg)	0.01	0.01	0.01
Readability d, Full Range (mg)	0.01	0.1	0.1
Repeatability (sd.), ≤5% of Full Load (mg)	0.01		
Repeatability (sd.), 5% of Full Load to Fine Range Max (mg)	0.02		
Repeatability (sd.), Fine Range Max to Full Range	0.02	0.1	0.1
Linearity Deviation, Typical (mg)	±0.06		
Linearity Deviation (mg)	±0.1		
Span Calibration Points (g)	50, 80	25, 50, 75, 100	50, 100, 150, 200
Calibration	Auto-Cal	Auto-Cal	Auto-Cal
Weighing units	Baht, carat, grain, gram, kilogram, milligram, mesgal, momme, Newton, ounce, pennyweight, pound, Tael (Hong Kong), Tael, (Singapore), Tael (Taiwan), tical, tola, troy ounce, custom (1)		
Applications	Weighing, Parts Counting, Percent Weighing, Check Weighing, Animal Weighing, Formulation, Density Determination, Totalization, Display Hold		
Stabilization time (typical)	8 s		
Sensitivity Temperature Drift (PPM/K)	2		
Typical Minimum Weight USP (USP K=2, U=0.10%)	20 mg		
Optimized Minimum -Weight (g) (USP, u=0.10%, k=2) SRP≤0.41d*	8.2 mg		
Display	Full-Color WQVGA Graphic LCD		
Display size	4.3 in / 10.9 cm (diagonal)		
Backlight	White LED		
Controls	4-wire resistive touch screen + 6 membrane keys		
Communication	RS-232, USBx2		
Power supply	AC Adapter Input: 100-240 VAC 0.3A 50-60 Hz AC Adapter Output: 12 VDC 0.84A		
Platform size (diameter)	80 mm / 3.1 in		
Assembled dimensions (W x D x H)	230 x 354 x 340 mm 9.1 x 13.9 x 13.4 inch		
Shipping dimensions (W x D x H)	387 x 507 x 531 mm 15.4 x 20.0 x 20.9 inch		
Net weight	5.1 Kg / 11.3 lb		
Shipping weight	7.8 Kg / 17.2 lb		

*SRP refers to the standard deviation for n replicate weightings ($n \geq 10$).

TABLE 9-2. SPECIFICATIONS

Model	AX124	AX124/E	AX224	AX224/E	AX324
Capacity	120g	120g	220g	220g	320g
Readability d	0.0001g				
Repeatability (sd.), ≤5% of Full Load	0.00008g				
Repeatability (sd.), 5% of Full Load to Full Range	0.0001g				
Linearity Deviation, Typical	±0.00006g				
Linearity Deviation	±0.0002g				
Span Calibration Points	25g, 50g 75g, 100g	25g, 50g 75g, 100g	50g, 100g 150g, 200g	50g, 100g 150g, 200g	100g 200g, 300g
Calibration	Auto-Cal	External	Auto-Cal	External	Auto-Cal
Weighing units	Baht, carat, grain, gram, kilogram, milligram, mesgal, momme, Newton, ounce, pennyweight, pound, Tael (Hong Kong), Tael, (Singapore), Tael (Taiwan), tical, tola, troy ounce, custom (1)				
Applications	Weighing, Parts Counting, Percent Weighing, Check Weighing, Animal Weighing, Formulation, Density Determination, Totalization, Display Hold				
Stabilization time (typical)	≤ 3 seconds				
Sensitivity Temperature Drift (PPM/K)	2				
Typical Min-Weight USP (u=0.10%,k=2)	0.16 g				
Optimized Min-Weight USP (u=0.10%,k=2) SRP ≤ 0.41d*	0.082 g				
GLP Minimum weighing value (U=1%, K=2)	0.02g				
Display	Full-Color WQVGA Graphic LCD				
Display size	4.3 in / 10.9 cm (diagonal)				
Backlight	White LED				
Controls	4-wire resistive touch screen + 6 membrane keys				
Communication	RS-232, USBx2				
Power supply	AC Adapter Input: 100-240 VAC 0.3A 50-60 Hz AC Adapter Output: 12 VDC 0.84A				
Platform size (diameter)	90 mm / 3.5 in				
Assembled dimensions (W x D x H)	230 x 354 x 340 mm 9.1 x 13.9 x 13.4 inch				
Shipping dimensions (W x D x H)	387 x 507 x 531 mm 15.4 x 20.0 x 20.9 inch				
Net weight	5.1 Kg / 11.3 lb				
Shipping weight	7.8 Kg / 17.2 lb				

*SRP refers to the standard deviation for n replicate weightings (n≥10).

TABLE 9-3. SPECIFICATIONS (continued)

Model	AX223	AX223/E	AX423	AX423/E	AX523	AX523/E	AX623	AX623/E
Capacity	220g	220g	420g	420g	520g	520g	620	620
Readability d	0.001g							
Repeatability (sd.), ≤5% of Full Load	0.0008g							
Repeatability (sd.), 5% of Full Load to Full Range	0.001g							
Linearity Deviation, Typical	±0.0006g							
Linearity Deviation	±0.002g							
Span Calibration Points	50g, 100g, 150g, 200g	50g, 100g, 150g, 200g	100g, 200g, 300g, 400g	100g, 200g, 300g, 400g	200g, 300g, 400g, 500g	200g, 300g, 400g, 500g	300g, 400g, 500g, 600g	300g, 400g, 500g, 600g
Calibration	Auto-Cal	External	Auto-Cal	External	Auto-Cal	External	Auto-Cal	External
Weighing units	Baht, carat, grain, gram, kilogram, milligram, mesgal, momme, Newton, ounce, pennyweight, pound, Tael (Hong Kong), Tael, (Singapore), Tael (Taiwan), tical, tola, troy ounce, custom (1),							
Applications	Weighing, Parts Counting, Percent Weighing, Check Weighing, Animal Weighing, Formulation, Density Determination, Totalization, Display Hold							
Stabilization time (typical)	≤ 2 seconds							
Sensitivity Temperature Drift (PPM/K)	3							
Typical Min-Weight USP (u=0.10%,k=2)	1.6 g							
Optimized Min- Weight USP (u=0.10%,k=2)	0.82 g							
GLP Minimum weighing value (U=1%, K=2)	0.2g							
Display	Full-Color WQVGA Graphic LCD							
Display size	4.3 in / 10.9 cm (diagonal)							
Backlight	White LED							
Controls	4-wire resistive touch screen + 6 membrane keys							
Communication	RS-232, USBx2							
Power supply	AC Adapter Input: 100-240 VAC 0.3A 50-60 Hz AC Adapter Output: 12 VDC 0.84A							
Platform size (diameter)	130 mm / 5.1 in							
Assembled dimensions (W x D x H)	230 x 354 x 340 mm 9.1 x 13.9 x 13.4 inch							
Shipping dimensions (W x D x H)	387 507 x 531 mm 15.4 x 20.0 x 20.9 inch							
Net weight	5.8Kg/ 12.8lb	5.6Kg/ 12.4lb	5.8Kg/ 12.8lb	5.6Kg/ 12.4lb	5.8Kg/ 12.8lb	5.6Kg/ 12.4lb	5.8Kg/ 12.8lb	5.6Kg/ 12.4lb
Shipping weight	8.5Kg/ 18.8lb	8.3Kg/ 18.3lb	8.5Kg/ 18.8lb	8.3Kg/ 18.3lb	8.5Kg/ 18.8lb	8.3Kg/ 18.3lb	8.5Kg/ 18.8lb	8.3Kg/ 18.3lb

*SRP refers to the standard deviation for n replicate weightings (n ≥ 10).

TABLE 9-4. SPECIFICATIONS (continued)

Model:	AX422	AX422/E	AX822	AX822/E
Capacity	420g	420g	820g	820g
Readability d	0.01g			
Repeatability (std. dev.) (g)	0.01g			
Linearity (g)	±0.02g			
Span Calibration Points (g)	100g, 200g 300g,400g	100g, 200g 300g,400g	200g, 400g 600g, 800g	200g, 400g 600g, 800g
Calibration	Auto-Cal	External	Auto-Cal	External
Weighing units	Baht, carat, grain, gram, kilogram, mesgal, momme, Newton, ounce, pennyweight, pound, Tael (Hong Kong), Tael (Singapore), Tael (Taiwan), tical, tola, troy ounce, custom (1)			
Applications	Weighing, Parts Counting, Percent Weighing, Check Weighing, Animal Weighing, Formulation, Density Determination, Totalization, Display Hold			
Stabilization time (typical)	≤ 1.5 seconds			
Sensitivity Temperature Drift (PPM/K)	3			
Typical Min-Weight USP(u=0.10%,k=2)	20.0 g			
Optimal Min-Weight USP(u=0.10%,k=2)	8.2 g			
Display	Full-Color WQVGA Graphic LCD			
Display size	4.3 in / 10.9 cm (diagonal)			
Backlight	White LED			
Controls	4-wire resistive touch screen + 6 membrane keys			
Communication	RS-232, USBx2			
Balance power input	12 VDC, 0.5A			
Power supply	AC Adapter Input: 100-240 VAC 0.3A 50-60 Hz AC Adapter Output: 12 VDC 0.84A			
Platform size	175 x 195 mm / 6.9 x 7.7 in			
Assembled dimensions (W x D x H)	230 x 354 x100 mm 9.1 x 13.9 x 4.0 inch			
Shipping dimensions (W x D x H)	392 x 557 x 301 mm 15.5 x 22.0 x 11.9 inch			
Net weight	4.6Kg/10.2lb	3.9Kg/8.6lb	4.6Kg/10.2lb	3.9Kg/8.6lb
Shipping weight	6.5Kg/14.4b	5.8Kg/12.8b	6.5Kg/14.4b	5.8Kg/12.8b

*SRP refers to the standard deviation for n replicate weightings (n ≥ 10).

TABLE 9-5. SPECIFICATIONS (continued)

Model	AX622	AX622/E	AX1502	AX1502/E	AX2202	AX2202/E	AX4202	AX4202/E	AX5202	AX6202	AX6202/E
Capacity	620g	620g	1520g	1520g	2200g	2200g	4200g	4200g	5200g	6200g	6200g
Readability d	0.01g										
Repeatability (sd.), ≤5% of Full Load	0.008g										
Repeatability (sd.), 5% of Full Load to Full Range	0.01g										
Linearity Deviation, Typical	±0.006g										
Linearity Deviation	±0.02g										
Span Calibration Points	300g, 400g, 500g, 600g	300g, 400g, 500g, 600g	500g, 1000g, 1500g	500g, 1000g, 1500g	500g, 1000g, 1500g, 2000g	500g, 1000g, 1500g, 2000g	1000g, 2000g, 3000g, 4000g	1000g, 2000g, 3000g, 4000g	2000g, 3000g, 4000g, 5000g	3000g, 4000g, 5000g, 6000g	3000g, 4000g, 5000g, 6000g
Calibration	Auto-Cal	External	Auto-Cal	External	Auto-Cal	External	Auto-Cal	External	Auto-Cal	Auto-Cal	External
Weighing units	Baht, carat, grain, gram, kilogram, mesgal, momme, Newton, ounce, pennyweight, pound, Tael (Hong Kong), Tael, (Singapore), Tael (Taiwan), tical, tola, troy ounce, custom (1)										
Applications	Weighing, Parts Counting, Percent Weighing, Check Weighing, Animal Weighing, Formulation, Density Determination, Totalization, Display Hold										
Stabilization time (typical)	≤ 1.5 seconds										
Sensitivity Temperature Drift (PPM/K)	3										
Typical Min-Weight USP(u=0.10%,k=2)	16 g										
Optimal Min-Weight USP(u=0.10%,k=2)	8.2 g										
GLP Minimum weighing value (U=1%, K=2)	2g										
Display	Full-Color WQVGA Graphic LCD										
Display size	4.3 in / 10.9 cm (diagonal)										
Backlight	White LED										
Controls	4-wire resistive touch screen + 6 membrane keys										
Communication	RS-232, USBx2										
Power supply	AC Adapter Input: 100-240 VAC 0.3A 50-60 Hz AC Adapter Output: 12 VDC 0.84A										
Platform size	175 x 195 mm / 6.9 x 7.7 in										
Assembled dimensions (W x D x H)	230 x 354 x100 mm 9.1 x 13.9 x 4.0 inch										
Shipping dimensions (W x D x H)	392 x 557 x 301 mm 15.5 x 22.0 x 11.9 inch										
Net weight	4.6Kg/ 10.2lb	3.9Kg/ 8.6lb	4.6Kg/ 10.2lb	3.9Kg/ 8.6lb	4.6Kg/ 10.2lb	3.9Kg/ 8.6lb	4.6Kg/ 10.2lb	3.9Kg/ 8.6lb	3.8Kg/ 8.4lb	4.6Kg / 10.2lb	3.9Kg / 8.6lb
Shipping weight	6.5Kg/ 14.4b	5.8Kg/ 12.8b	6.5Kg/ 14.4b	5.8Kg/ 12.8b	6.5Kg/ 14.4b	5.8Kg/ 12.8b	6.5Kg/ 14.4b	5.8Kg/ 12.8b	5.7Kg/ 12.6lb	6.5Kg / 14.4lb	5.8Kg / 12.8lb

*SRP refers to the standard deviation for n replicate weightings (n ≥ 10).

TABLE 9-6. SPECIFICATIONS (continued)

Model:	AX4201	AX4201/E	AX8201	AX8201/E	AX12001	AX12001/E
Capacity	4200g	4200g	8200g	8200g	12000g	12000g
Readability d	0.1g					
Repeatability (sd.), ≤5% of Full Load	0.08g					
Repeatability (sd.), 5% of Full Load to Full Range	0.1g					
Linearity Deviation, Typical	±0.06g					
Linearity Deviation	±0.2g					
Span Calibration Points (g)	1000g 2000g 3000g 4000g	1000g 2000g 3000g 4000g	2000g 4000g 6000g 8000g	2000g 4000g 6000g 8000g	3000g 5000g 7000g 9000g 12000g	3000g 5000g 7000g 9000g 12000g
Calibration	Auto-Cal	External	Auto-Cal	External	Auto-Cal	External
Weighing units	Baht, carat, grain, gram, kilogram, mesgal, momme, Newton, ounce, pennyweight, pound, Tael (Hong Kong), Tael, (Singapore), Tael (Taiwan), tical, tola, troy ounce, custom (1)					
Applications	Weighing, Parts Counting, Percent Weighing, Check Weighing, Animal Weighing, Formulation, Density Determination, Totalization, Display Hold					
Stabilization time (typical)	≤ 1.5 seconds					
Sensitivity Temperature Drift (PPM/K)	5					
Typical Min-Weight USP (u=0.10%,k=2)	160 g					
Optimized Min-Weight USP (u=0.10%,k=2)	82 g					
GLP Minimum weighing Value (U=1%, K=2)	20g					
Display	Full-Color WQVGA Graphic LCD					
Display size	4.3 in / 10.9 cm (diagonal)					
Backlight	White LED					
Controls	4-wire resistive touch screen + 6 membrane keys					
Communication	RS-232, USBx2					
Power supply	AC Adapter Input: 100-240 VAC 0.3A 50-60 Hz AC Adapter Output: 12 VDC 0.84A					
Platform size	175 x 195 mm / 6.9 x 7.7 in					
Assembled dimensions (W x D x H)	230 x 354 x 100 mm 9.1 x 13.9 x 4.0 inch					
Shipping dimensions (W x D x H)	392 x 557 x 301 mm 15.5 x 22.0 x 11.9inch					
Net weight	4.6Kg / 10.2lb	3.9Kg / 8.6lb	3.8Kg / 8.4lb	3.4Kg / 7.5lb	4.6Kg / 10.2lb	3.8Kg / 8.4 lb
Shipping weight	6.5Kg / 14.4lb	5.8Kg / 12.8lb	5.7Kg / 12.6lb	5.3Kg / 11.6lb	6.5Kg / 14.4lb	5.7Kg / 12.6 lb

*SRP refers to the standard deviation for n replicate weightings (n≥10).

TABLE 9-7. SPECIFICATIONS (continued)

Model	AX85M	AX125DM	AX225DM	AX124M	AX224M	AX324M	AX223M	AX423M	AX523M	AX623M
Max	82g	82g/120g	102g/220g	120g	220g	320g	220g	420g	520g	620g
Min	0.001g	0.001g	0.001g	0.01g	0.01g	0.01g	0.02g	0.02g	0.02g	0.02g
d=	0.00001	0.00001/ 0.0001	0.00001/ 0.0001	0.0001g			0.001g			
e=	0.001g	0.001g	0.001g	0.001g			0.01g			
Approval Class	I	I	I	I			II			
Repeatability (sd.), ≤5% of Full Load	0.00001g			0.00008g			0.0008g			
Repeatability (sd.), 5% of Full Load to Fine Range Max	0.00002g			-			-			
Repeatability (sd.), Fine Range Max to Full Range	0.00002	0.0001	0.0001	0.0001g			0.001g			
Linearity Deviation, Typical	±0.00006g			±0.00006g			±0.0006g			
Linearity Deviation	±0.0001g			±0.0002g			±0.002g			
Span Calibration Points	25g 50g 75g 100g	50g 80g	50g 100g 150g 200g	25g 50g 75g 100g	50g 100g 150g 200g	100g 200g 300g	50g 100g 150g 200g	100g 200g 300g 400g	200g 300g 400g 500g	300g 400g 500g 600g
Calibration	Auto-Cal									
Weighing units	milligram, gram, carat									
Applications	Weighing, Parts Counting, Percent Weighing, Check Weighing, Animal Weighing, Formulation, Density Determination, Totalization, Display Hold									
Stabilization time (typical)	≤ 8 seconds			≤ 3 seconds			≤ 2 seconds			
Sensitivity Temperature Drift (PPM/K)	2			2			3			
Typical Min-Weight USP (u=0.10%,k=2)	20 mg			0.16 g			1.6 g			
Optimal Min-Weight USP (u=0.10%,k=2)	8.2 mg			0.082 g			0.82 g			
GLP Minimum weighing value (U=1%, K=2)	2 mg			0.02g			0.2g			
Display	Full-Color WQVGA Graphic LCD									
Display size	4.3 in / 10.9 cm (diagonal)									
Backlight	White LED									
Controls	4-wire resistive touch screen + 6 membrane keys									
Communication	RS-232, USBx2									
Power supply	AC Adapter Input: 100-240 VAC 0.3A 50-60 Hz AC Adapter Output: 12 VDC 0.84A									
Platform size (diameter)	80 mm / 3.1 in			90 mm / 3.5 in			130 mm / 5.1 in			
Assembled dimensions (W x D x H)	230 x 354 x 340 mm 9.1 x 13.9 x 13.4 inch			230 x 354 x 340 mm 9.1 x 13.9 x 13.4 inch			230 x 354 x 340 mm 9.1 x 13.9 x 13.4 inch			
Shipping dimensions (W x D x H)	387 x 507 x 531 mm 15.4 x 20.0 x 20.9 inch			387 x 507 x 531 mm 15.4 x 20.0 x 20.9 inch			387 x 507 x 531 mm 15.4 x 20.0 x 20.9 inch			
Net weight	5.1 Kg / 11.3 lb			5.1 Kg / 11.3 lb			5.8 Kg / 12.8 lb			
Shipping weight	7.8 Kg / 17.2 lb			7.8 Kg / 17.2 lb			8.5 Kg / 18.8 lb			

Note: M = OIML Approved

*SRP refers to the standard deviation for n replicate weightings (n ≥ 10).

TABLE 9-8. SPECIFICATIONS (continued)

MODEL	AX1502M	AX2202M	AX4202M	AX5202M	AX6202M	AX8201M	AX12001M
Max	1520g	2200g	4200g	5200g	6200g	8200g	12000g
Min	0.5g	0.5g	0.5g	0.5g	0.5g	5g	5g
d=	0.01g					0.1g	
e=	0.1g					1g	
Approval Class	II						
Repeatability (sd.), ≤5% of Full Load (g)	0.008g					0.08g	
Repeatability (sd.), 5% of Full Load to Full Range (g)	0.01g					0.1g	
Linearity Deviation, Typical (g)	±0.006g					±0.06g	
Linearity Deviation (g)	±0.02g					±0.2g	
Span Calibration Points	500g 1000g, 1500g	500g 1000g 1500g 2000g	1000g 2000g 3000g 4000g	2000g 3000g 4000g 5000g	3000g 4000g 5000g 6000g	2000g 4000g 6000g 8000g	3000g 5000g 7000g 9000g 12000g
Calibration	Auto-Cal						
Weighing units	kilogram, gram, carat						
Applications	Weighing, Parts Counting, Percent Weighing, Check Weighing, Animal Weighing, Formulation, Density Determination, Totalization, Display Hold						
Stabilization time (typical)	≤ 1.5 seconds						
Sensitivity Temperature Drift (PPM/K)	3					5	
Typical Min-Weight USP (u=0.10%,k=2)	16 g					160 g	
Optimal Min-Weight USP (u=0.10%,k=2)	8.2 g					82 g	
GLP Minimum weighing value (U=1%, K=2)	2g					20g	
Display	Full-Color WQVGA Graphic LCD						
Display size	4.3 in / 10.9 cm (diagonal)						
Backlight	White LED						
Controls	4-wire resistive touch screen + 6 membrane keys						
Communication	RS-232, USBx2						
Power supply	AC Adapter Input: 100-240 VAC 0.3A 50-60 Hz AC Adapter Output: 12 VDC 0.84A						
Platform size (diameter)	175x195 mm / 6.9x7.7 in						
Assembled dimensions (W x D x H)	230 x 354 x 100 mm 9.1 x 13.9 x 4.0 inch						
Shipping dimensions (W x D x H)	392 x 557 x 301 mm 15.5 x 22.0 x 11.9 inch						
Net weight	4.6 Kg / 10.2 lb					3.8 Kg / 8.4 lb	
Shipping weight	6.5 Kg / 14.4 lb					5.7 Kg / 12.6 lb	

Note: M = OIML Approved

*SRP refers to the standard deviation for n replicate weightings (n ≥ 10).

TABLE 9-9. SPECIFICATIONS (continued)

Model	AX224N	AX223N/E	AX423N AX423N/E	AX523N/E	AX623N/E	AX622N/E	AX1502N/E	AX2202N/E	AX4202N/E	AX6202N/E	AX8201N/E	AX120001N/E
Max	220g	220g	420g	520g	620g	620g	1520g	2200g	4200g	6200g	8200g	12000g
Min	0.01g	0.02g	0.02g	0.02g	0.02g	0.5g	0.5g	0.5g	0.5g	0.5g	5g	5g
d=	0.0001g or 0.001g	0.001g or 0.01g				0.01g or 0.1g				0.1g or 1g		
e=	0.001g	0.01g				0.1g				1g		
Approval Class	I					II						
Repeatability (sd.), ≤5% of Full Load	0.00008 g	0.0008g				0.008g				0.08g		
Repeatability (sd.), 5% of Full Load to Full Range	0.0001g	0.001g				0.01g				0.1g		
Linearity Deviation, Typical	±0.0000 6g	±0.0006g				±0.006g				±0.06g		
Linearity Deviation	±0.0002 g	±0.002g				±0.02g				±0.2g		
Span Calibration Points	50g 100g 150g 200g	50g 100g 150g 200g	100g 200g 300g 400g	200g 300g 400g 500g	300g 400g 500g 600g	300g 400g 500g 600g	500g 1000g 1500g	500g 1000g 1500g 2000g	1000g 2000g 3000g 4000g	3000g 4000g 5000g 6000g	2000g 4000g 6000g 8000g	3000g 5000g 7000g 9000g 12000g
Calibration	Auto-Cal	External	Auto-Cal External	External	External	External	External	External	External	External	External	External
Weighing units	gram, milligram, carat, pennyweight, grain, ounce, troy ounce					gram, kilogram, carat, pennyweight, grain, pound, ounce, troy ounce						
Applications	Weighing, Parts Counting, Percent Weighing, Check Weighing, Animal Weighing, Formulation, Density Determination, Totalization											
Stabilization time (typical)	≤ 3 seconds	≤2 seconds				≤1.5 seconds						
Sensitivity Temperature Drift (PPM/K)	2	3				3				5		
Typical Min-Weight USP (u=0.10%,k=2)	0.16g	1.6 g				16 g				160 g		
Optimal Min-Weight USP (u=0.10%,k=2)	0.082 g	0.82 g				8.2 g				82 g		
GLP Minimum weighing value (U=1%, K=2)	0.02g	0.2g				2g				20g		
Display	Full-Color WQVGA Graphic LCD											
Display size	4.3 in / 10.9 cm (diagonal)											
Backlight	White LED											
Controls	4-wire resistive touch screen + 6 membrane keys											
Communication	RS-232, USBx2											
Power supply	AC Adapter Input: 100-240 VAC 0.3A 50-60 Hz AC Adapter Output: 12 VDC 0.84A											
Platform size (diameter)	90 mm / 3.5 in	130 mm / 5.1 in				175x195 mm / 6.9x7.7 in						
Assembled dimensions (W x D x H)	354x230x340 mm 13.9x9.1x13.4 inch					354x230x100 mm 13.9x9.1x4.0 inch						
Shipping dimensions (W x D x H)	557x392x301 mm 22.0x15.5x11.9 inch					392 x 557 x 301 mm 15.5 x 22.0 x 11.9 inch						
Net weight	5.1 Kg / 11.3 lb	5.8 Kg / 12.8 lb 5.6 Kg / 12.4 lb				3.9 Kg / 8.6 lb				3.4 Kg / 7.5 lb		
Shipping weight	7.8 Kg / 17.2 lb	8.5 Kg / 18.8 lb 8.3 Kg / 18.3 lb				5.8 Kg / 12.8 lb				5.3 Kg / 11.6 lb		

Note: N = NTEP Approved

*SRP refers to the standard deviation for n replicate weightings (n ≥ 10).

Drawings and Dimensions

Fully assembled dimensions

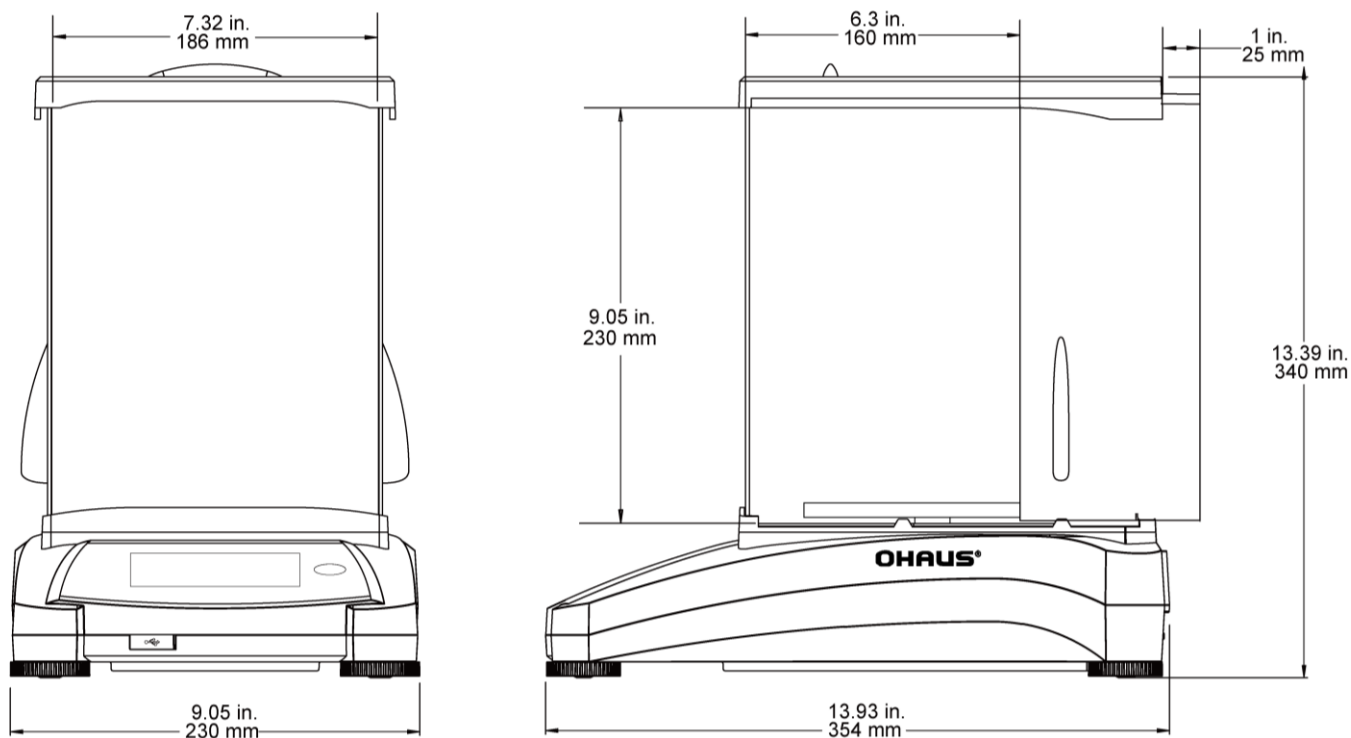

Figure 9-1. Draft Shield models

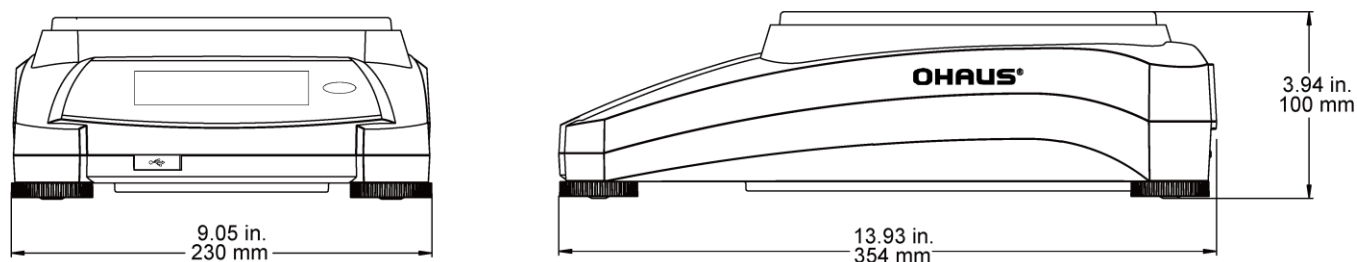

Figure 9-2. Non-Draft Shield models

9.2 Parts and Accessories

TABLE 9-5. ACCESSORIES

DESCRIPTION	PART NUMBER
Auxiliary Display AD7-RS	30472064
SF40A Impact Printer	80241992
Density Determination Kit	80253384
Sinker Glass for Density Kit	83034024
Cable, USB Device (Type A-B)	83021085
Security Device (Laptop Lock)	80850043
RS232 Cable, PC 9 Pin	80500525
Dust Cover	30093334
In Use Cover for 0.1mg and 1mg model	30111792
In Use Cover for 0.01g and 0.1g model	30111777
ION-100A EU Standalone Ionizer	30095929
ION-100A US Standalone Ionizer	30130302
ION-100A AP Standalone Ionizer	30130303

9.3 Communication

9.3.1 Interface Commands

Commands listed in the following table will be acknowledged by the balance.
The balance will return “ES” for invalid commands.

TABLE 9-6. ADVENTURER INTERFACE COMMAND LIST

Command Characters	Function
IP	Immediate Print of displayed weight (stable or unstable).
P	Print displayed weight (stable or unstable).
CP	Continuous Print. Note: for AX...N...type models, when LFT is turned ON, CP could not work.
SP	Print on Stability.
SLP	Auto Print stable non-zero displayed weight.
SLZP	Auto Print stable non-zero weight and stable zero reading.
xP	Interval Print x = Print Interval (1-3600 sec) 0P ends interval Print
0P	See above
H	Enter Print Header Lines
Z	Same as pressing Zero Key
T	Same as pressing Tare Key.
xT	Establish a preset Tare value in displayed unit. X = preset tare value. Sending 0T clears tare (if allowed).
PT	Prints Tare weight stored in memory.
ON	Brings out of Standby
OFF	Goes to Standby.
C	Begin Span Calibration
IC	Begin internal Calibration, same as trigger from calibration menu.
AC	Abort Calibration. Attention: when LFT ON, the operation is not allowed.
PSN	Print Serial Number.
PV	Print terminal software version, base software version and LFT ON (if LFT is set ON).
x#	Set Counting APW (x) in grams. (must have APW stored)
P#	Print Counting application APW.
x%	Set Percent application reference weight (x) in grams. (must have reference weight stored)
P%	Print Percent application reference weight.
xS	0 = print unstable data, same as IP; 1 = print stable only ¹⁾ , same as SP.
xRL	0 = disable response; 1 = enable response. This command only controls the “OK!” response.
PFMT [n]; PFMT space N	n=0 default OHAUS mode n=1 MT mode n=2 Sartorius mode

9.3.2 RS232 (DB9) Pin Connections

- Pin 2: Balance transmit line (TxD)
- Pin 3: Balance receive line (Rx/D)
- Pin 5: Ground signal (GND)
- Pin 7: Clear to send (hardware handshake) (CTS)
- Pin 8: Request to send (hardware handshake) (RTS)

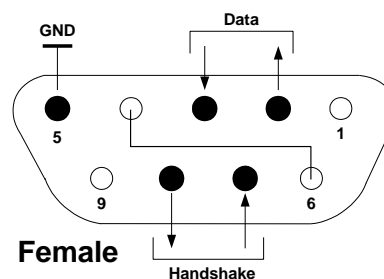

9.4 The USB Interface

The Ohaus USB Interface is a unique solution to the problem of connecting a balance to a computer using a Universal Serial Bus (USB). USB devices are categorized into classes such as disk drives, digital cameras, printers, etc. Balances do not have a commonly used class so the Ohaus USB interface uses a generic interface based on the RS232 serial standard.

Data sent from the balance to a computer is in USB format. The USB data is directed to a *virtual port*. This port then appears as an RS232 port to the application program.

When sending a command from a computer to the balance, the application program sends a command to the *virtual port* as if it were an RS232 port. The computer then directs the command from the *virtual port* to the computer's USB connector where the balance is connected. The port receives the USB signal and reacts to the command.

The USB Interface includes a CD with the software drivers to create the required *virtual port* on the computer.

System Requirements

- PC running Windows 98®, Windows 98SE®, Windows ME®, Windows 2000®, Windows XP®, Windows 7® or Windows 8® (32-bit).
- Available USB port (Type A, 4-pin, female)

USB Connection

The balance's USB port terminates with a 4-pin, female, USB Type B connector.

A USB Cable (type B/male to type A/male) is required (not supplied).

1. Ensure that the balance is powered on and working properly.
2. Power on the computer and verify that its USB port is enabled and working properly.
3. Plug the cable's USB connectors into the computer's USB port and the balance's USB port. Windows® should detect a USB device and the New Hardware Wizard will be initialized.

Virtual Port Software Installation

1. Insert the supplied CD into the computer's CD drive.
Different versions of Windows® have slightly different steps to load the driver that is on the CD. In all versions the New Hardware Wizard guides you through the required steps to select the driver that is located on the CD.
2. After clicking Finish, the virtual port should be ready for use.
Windows® typically adds the virtual port in sequence after the highest number COM port. For example, on PC's equipped with up to 4 COM ports, the virtual port will be COM5.

When using the USB interface with programs that limit the number of COM port designations (e.g. Ohaus MassTracker allows only COM1, 2, 3, & 4), it may be necessary to assign one of these port numbers to the new virtual port.



Example of Windows XP Hardware Wizard

This can be done in the Port Settings of the Device Manager utility, found in the Windows Control Panel.

USB INPUT

The balance will respond to various commands sent via the interface adapter. Terminate the following commands when with a [CR] or [CRLF].

Adventurer Commands

?	When unstable, object below min-weight
zC	perform span calibration
0S	print unstable data
1S	print stable data only
P	same as pressing Print
SP	print stable weight only
IP	immediate print of displayed weight (stable or unstable)
CP	Continuous print of weights
SLP	Auto-print stable non-zero weight only
LZP	Auto-print stable non-zero weight and zero reading
xP	Auto-print on 1 to 3600 second intervals (x = 1 to 3600)
0P	Ends interval print
T	same as pressing Tare
Z	same as pressing Zero
PV	print software version

Auto-Print Operation





Once Auto-Print is activated in the menu, the balance will send data as required. If there is data in the print buffer the printer will finish printing this data.

10. SOFTWARE UPDATES

Ohaus is continuously improving its balance software. To obtain the latest release, please contact your Authorized Ohaus Dealer or Ohaus Corporation.

11. COMPLIANCE

Compliance to the following standards is indicated by the corresponding mark on the product.

Mark	Standard
	This product complies with the applicable harmonized standards of EU Directives 2011/65/EU (RoHS), 2014/30/EU (EMC), 2014/35/EU (LVD) and 2014/31/EU (NAWI). The EU Declaration of Conformity is available online at www.ohaus.com/ce .
	This product complies with the EU Directive 2012/19/EU (WEEE). Please dispose of this product in accordance with local regulations at the collecting point specified for electrical and electronic equipment. For disposal instructions in Europe, refer to www.ohaus.com/weee .
	EN 61326-1
	CAN/CSA-C22.2 No. 61010-1 UL Std. No. 61010-1

Important notice for AX...M verified weighing instruments in the EU

When the instrument is used in trade or a legally controlled application it must be set up, verified and sealed in accordance with local weights and measures regulations. It is the responsibility of the purchaser to ensure that all pertinent legal requirements are met.

Weighing Instruments verified at the place of manufacture bear the following supplementary metrology marking on the descriptive plate."

 **CE MXX 1259**

Weighing Instruments to be verified in two stages have no supplementary metrology marking on the descriptive plate. The second stage of conformity assessment must be carried out by the applicable weights and measures authorities.

If national regulations limit the validity period of the verification, the user of the weighing instrument must strictly observe the re-verification period and inform the weights and measures authorities.

As verification requirements vary by jurisdiction, the purchaser should contact their local weights and measures office if they are not familiar with the requirements.

ISED Canada Compliance Statement:

This Class A digital apparatus complies with Canadian ICES-001.

ISO 9001 Registration

The management system governing the production of this product is ISO 9001 certified.

FCC SUPPLIER DECLARATION OF CONFORMITY

Unintentional Radiator per 47CFR Part B

Trade Name: OHAUS CORPORATION

Model: AX

Party issuing Supplier's Declaration of Conformity:

Ohaus Instruments (Changzhou) Co., Ltd.

Building C, No. 6 Zhengqiang Road, Xuejia Town, Xinbei District, Changzhou

Jiangsu 213022,

China

Phone: +86 519 85287270

Responsible Party – U.S. Contact Information:

Ohaus Corporation

8 Campus Drive, Suite 105

Parsippany, NJ 07054

United States

Phone: +1 973 377 9000

Web: www.ohaus.com**FCC Compliance Statement:**

Note: This equipment has been tested and found to comply with the limits for a Class A digital device, pursuant to part 15 of the FCC Rules. These limits are designed to provide reasonable protection against harmful interference when the equipment is operated in a commercial environment. This equipment generates, uses, and can radiate radio frequency energy and, if not installed and used in accordance with the instruction manual, may cause harmful interference to radio communications. Operation of this equipment in a residential area is likely to cause harmful interference in which case the user will be required to correct the interference at his own expense.

Changes or modifications not expressly approved by the party responsible for compliance could void the user's authority to operate the equipment.

LIMITED WARRANTY

Ohaus products are warranted against defects in materials and workmanship from the date of delivery through the duration of the warranty period. During the warranty period Ohaus will repair, or, at its option, replace any component(s) that proves to be defective at no charge, provided that the product is returned, freight prepaid, to Ohaus.

This warranty does not apply if the product has been damaged by accident or misuse, exposed to radioactive or corrosive materials, has foreign material penetrating to the inside of the product, or as a result of service or modification by other than Ohaus. In lieu of a properly returned warranty registration card, the warranty period shall begin on the date of shipment to the authorized dealer. No other express or implied warranty is given by Ohaus Corporation. Ohaus Corporation shall not be liable for any consequential damages.

As warranty legislation differs from state to state and country to country, please contact Ohaus or your local Ohaus dealer for further details.