

# User Instructions

## Tablet camera

for microscopes

**KERN**

**ODC-2**

ODC 241

Version 1.1  
09/2022







# KERN ODC-2

Version 1.0 01/2019

## User Instructions

### Tablet camera for microscopes

---

---

## Table of contents

<b>1</b>	<b>Before use .....</b>	<b>3</b>
1.1	General notes.....	3
1.2	Storage .....	3
<b>2</b>	<b>Scope of supply .....</b>	<b>4</b>
<b>3</b>	<b>Nomenclature .....</b>	<b>5</b>
<b>4</b>	<b>Technical data .....</b>	<b>9</b>
<b>5</b>	<b>Operation .....</b>	<b>11</b>
5.1	Unpacking and setting up .....	11
5.2	Start microscope software (S-EYE).....	13
5.3	User interface and functions of the S-EYE microscope software.....	14
5.3.1	Effect – Setting the camera parameters.....	15
5.3.2	Capturing and playing back images and videos .....	16
5.3.3	Transferring picture and video files to a PC .....	17
5.3.4	Measurements .....	18
5.3.5	Image analysis .....	22
<b>6</b>	<b>Service .....</b>	<b>25</b>
<b>7</b>	<b>Disposal.....</b>	<b>25</b>
<b>8</b>	<b>Further information.....</b>	<b>25</b>

# **1 Before use**

## **1.1 General notes**

You must open the packaging carefully, to make sure that none of the accessories in the packaging fall on the floor and get broken.

You should also avoid getting dirt or finger prints in the area of the camera sensor, because in most cases this will reduce image clarity.

The sensors and electronics inside the camera are extremely sensitive to light. For this reason never leave the camera in direct sunlight for long periods of time.

Where possible the tablet should not be used in humid environments. Using it in an environment which is always dry will automatically increase the service life.

## **1.2 Storage**

You should ensure that the device is not exposed to direct sunlight, temperatures which are too high or too low, vibrations, dust or a high level of humidity.

The ideal temperature range is between 0 and 40°C and a relative humidity of 85% should not be exceeded.

Sudden temperature fluctuations may cause fog inside the tablet. The tablet should therefore be stored in a bag or have a protective sleeve to protect it from these fluctuations.

## 2 Scope of supply



Tablet camera

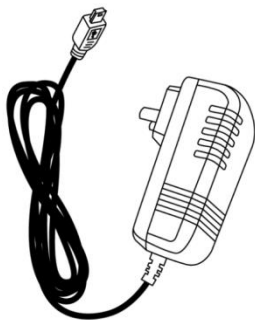

Power adapter



User Instructions

3 Nomenclature



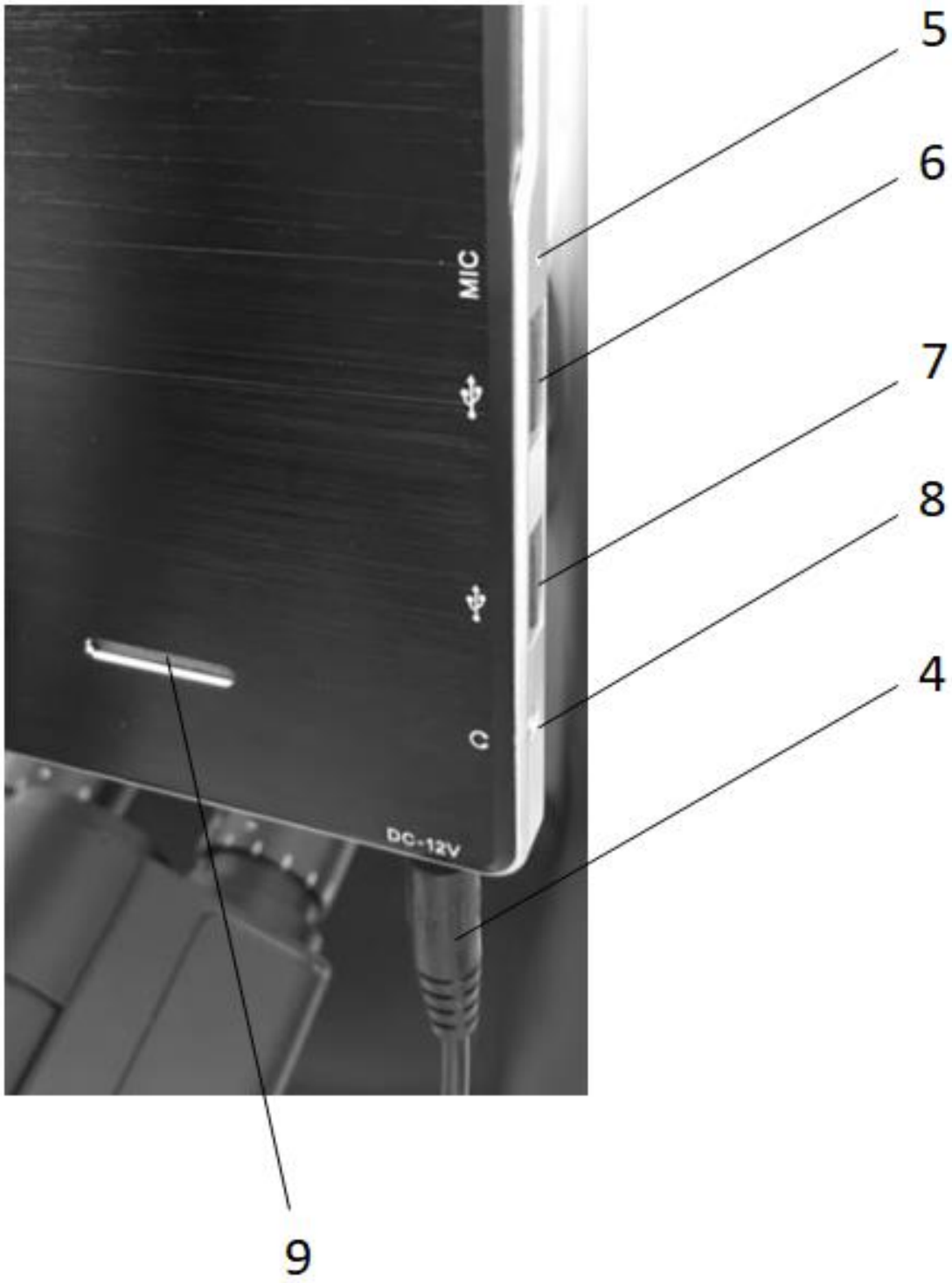

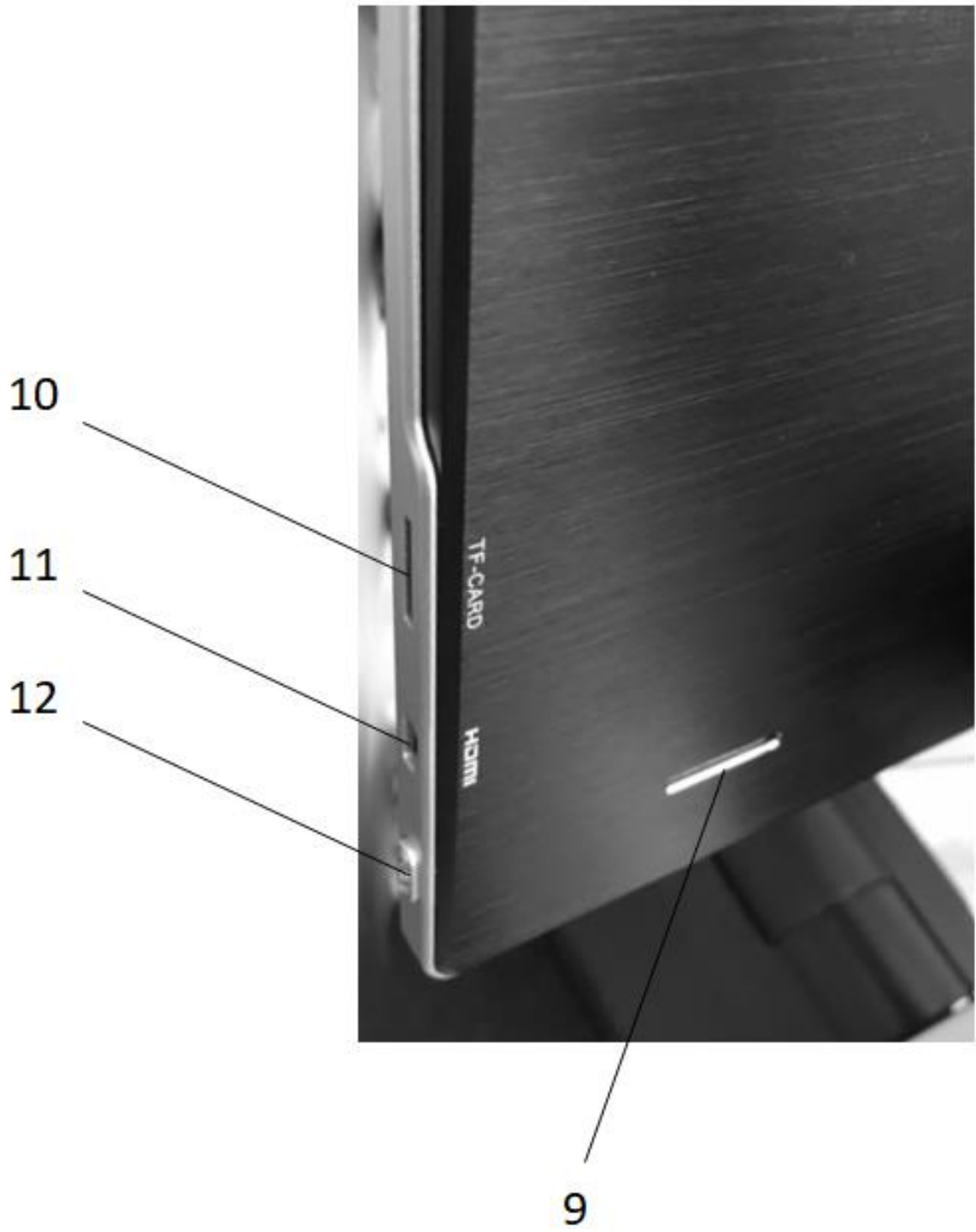



<b>Part number</b>	<b>Description</b>	<b>Part number</b>	<b>Description</b>
1	Tablet / Touch display	7	USB port PC mouse connection
2	Camera housing	8	Connection socket for headphones
3	Camera sensor	9	Loud speaker
4	Power connector	10	Micro SD slot
5	Microphone	11	Micro HDMI port
6	USB port	12	On/Off switch

## 4 Technical data

Screen	9.7" LCD touchscreen
CPU	Quad Core Cortex-A17; 1.8 GHz
Screen resolution	2048x1536 pixels
Sensor	1/2.5" CMOS
Frames per second (fps)	30 fps @ 1024x768
Pixel size	2.2 $\mu\text{m}$ x 2.2 $\mu\text{m}$
Photo format	JPEG
Input voltage	12 V DC (no battery operation)
Operating system	Android 5.1
Interfaces	WLAN, USB 2.0, Micro SD, Micro HDMI
App	S-eye
Language	English
Packaging dimensions	275x230x85 mm
Weight	Without packaging: 0.65 kg With packaging: 1.05 kg

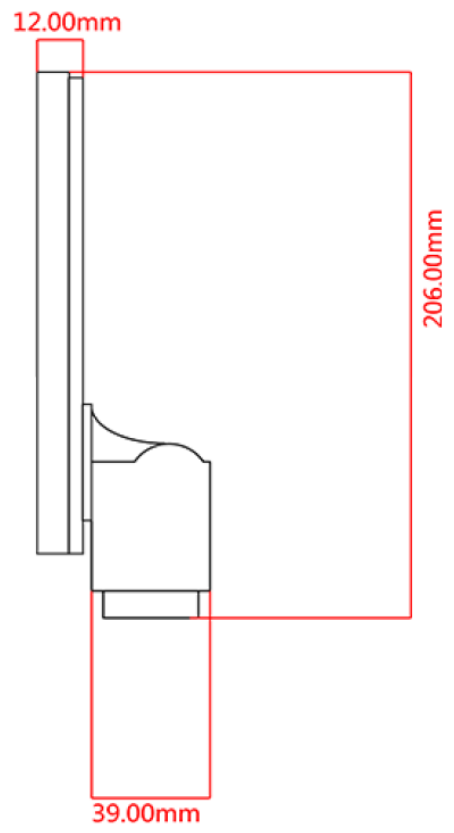
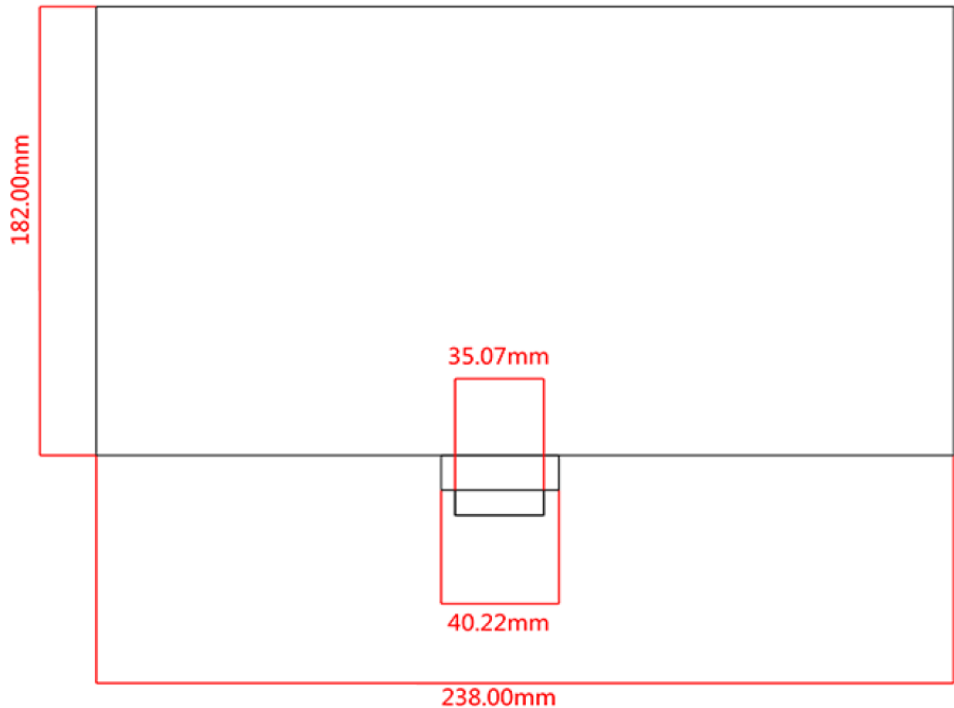

## 5 Operation

### 5.1 Unpacking and setting up

1. Take the tablet camera and power adapter out of the packaging and remove the packaging sleeves
2. Remove the protective film from the display of the tablet
3. Undo the screws on the cover on the back of the camera and remove the protective film underneath
4. Fit the tablet camera to the trinocular connection of the microscope

**To do this you need a C-mount adapter, which fits the microscope you are using. (For an example, see figure on page 12)**

5. Connect the power supply using the power adapter

**The power connector is located on the left on the underside of the tablet**

**Tablet camera**



**C-mount adapter**



**Microscope**



## 5.2 Start microscope software (S-EYE)

1. Press the On/Off switch in order to start the tablet (operating system: Android)

To do this the tablet must have a permanent power supply  
Battery operation is not possible

2. The S-EYE microscope software usually starts automatically

If this does not happen, then this App (from the desktop of the tablet) can be started manually (touchscreen)

*See figure below*

3. To operate the tablet/microscope software easily, you can connect a PC mouse to the USB port at any time



*Tablet start screen*

### 5.3 User interface and functions of the S-EYE microscope software

S-EYE offers its users an extensive range of functions and thereby guarantees the very best digital sample analysis.

**As well as live image transfer, the following tools are also included:**  
*(can be selected on the righthand edge of the scree)*

1. Effect – Setting the camera parameters
2. Measure – Various measuring functions
3. Playback – Image and video playback/image analysis
4. Snap – Image capture
5. Record – Video recording
6. Setting – General settings

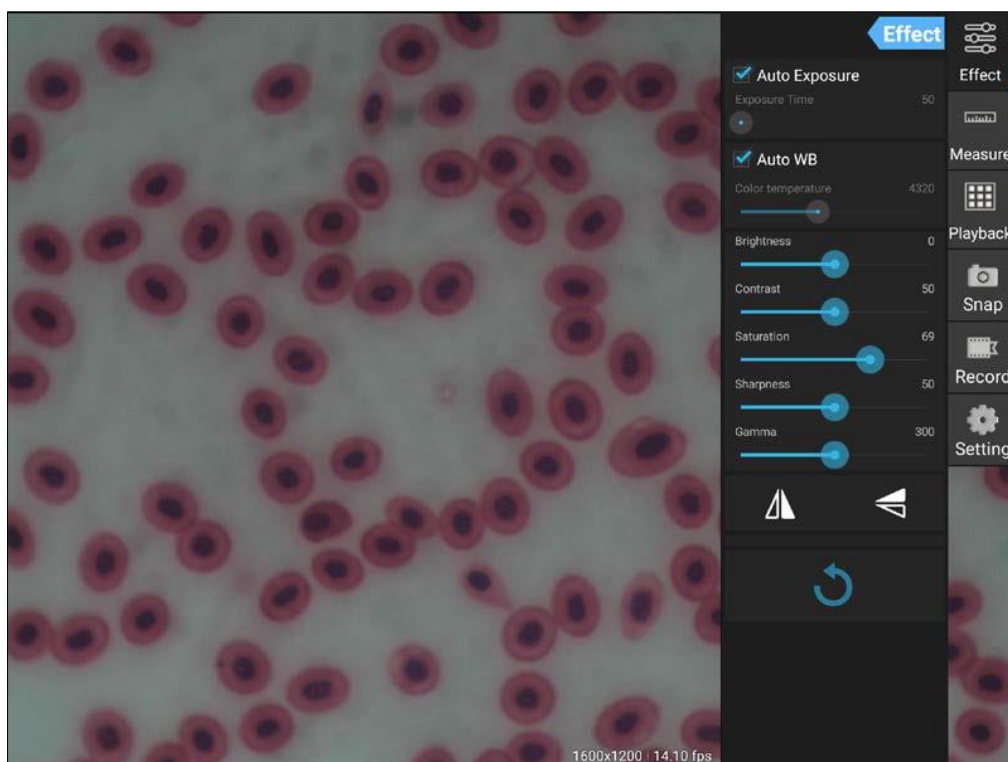

### 5.3.1 Effect – Setting the camera parameters

If the imaging from the live transfer is not satisfactory, then there are a few options to optimise this imaging, using the “Effect” program category.

#### 1. Exposure

- Auto mode:  
Exposure time adjusts automatically
- Manual mode:  
Exposure time is adjusted manually

#### 2. Auto WB (white balance)

- Auto mode:  
Colour temperature adjusts automatically
- Manual mode:  
Colour temperature is adjusted manually

#### 3. Further image processing

- Brightness
- Contrast
- Saturation
- Sharp
- Gamma

#### 4. Flip function

- Horizontal image mirroring
- Vertical image mirroring

#### 5. Reset

The settings implemented for image processing can be saved under four different profiles.

To do this click on the following symbol: 

You can also reset to the original settings using the “factory” profile.

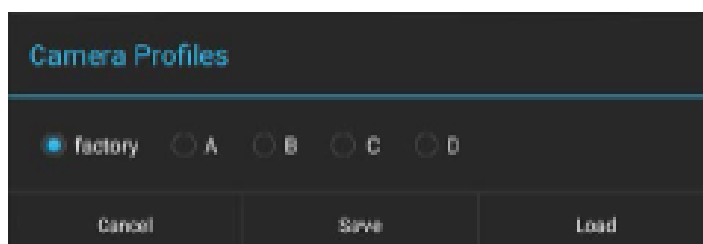
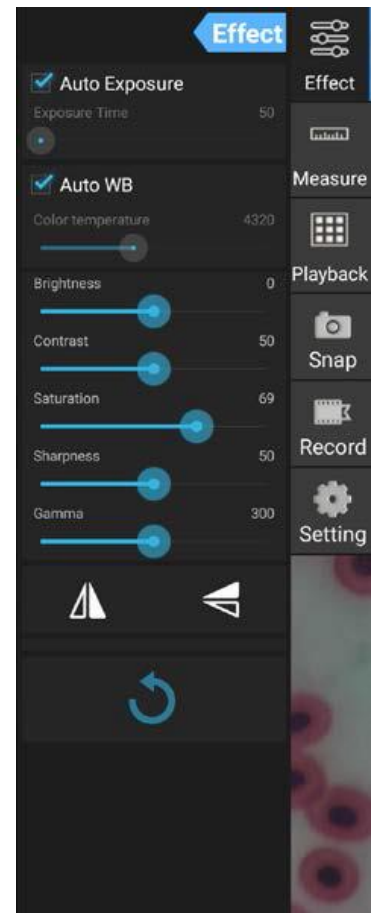

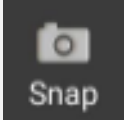
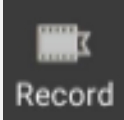
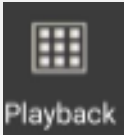

**5.3.2 Capturing and playing back images and videos**

	<p>Click on the Snap button to capture an image.</p> <p><i>You can set the image size in the “Setting” program category under “Picture Size”.</i></p>
	<p>Click on the Record button to record a video.</p> <p><i>Depending on the video size selected for live transfer (“Setting” program category under “Preview Size”), videos with a size of up to 1080p (Full-HD) can be recorded.</i></p>
	<p>All images and videos are saved and can be recalled using the Playback button. In order to open the required image or video, you need to double click.</p> <p><i>You can specify the default storage location for images and videos in the “Setting” program category under “File Storage Path”</i></p> <p><i>Using the “Popup file dialog when saving file” you can set whether the dialogue window should appear to confirm each image or video.</i></p> <p><i>Under “Enable built-in image viewer” you can set whether images can be opened using the standard Android gallery or in the built-in image display program (see 5.3.4 Image analysis).</i></p>

### 5.3.3 Transferring picture and video files to a PC

To transfer the created picture and video files to a PC, the following steps must be carried out:

1. Insert the USB-stick to the tablet (folder structure will be created)
2. Start the **Explorer** in the Android menu (minimise S-EYE software for this purpose)
3. Open **NAND FLASH** storage
4. Scroll to the **S-EYE** folder and open it
5. Select and open the folder **Pictures**
6. Click on **Multi** in the menu bar and select the files you want
7. Then click on **Editor** and select **Copy**
8. Go to **Home** and select **USB storage(HOST)**
9. Click on **Past** in the **Editor** and the selected files will be saved

The USB-stick can then be removed and plugged into the PC.

### 5.3.4 Measurements

In order to be able to take measurements, calibration must be carried out first, which will synchronise the magnification settings of the microscope and the image characteristics of live transfer on the tablet camera.

#### Calibration:

1. Place the object holder with integrated scale onto the stage of the microscope
2. Click on the Measure button
3. Click on “Add” (or “+”) in the lower area of the “Calibrations” area

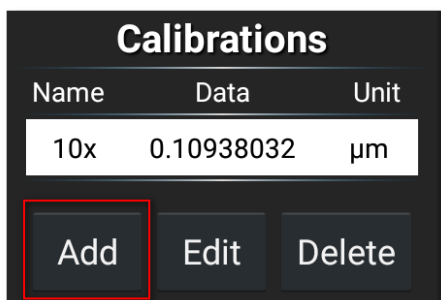

4. Follow the instructions which are displayed, step by step

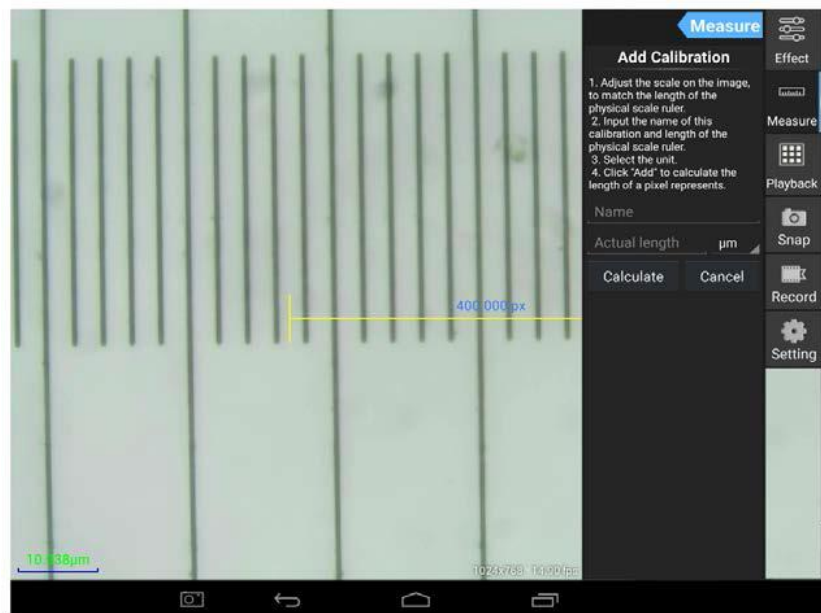

- Adjust the scale on the image to match the length of the physical scale ruler  
You can move the scale or alter the length using the touch function.

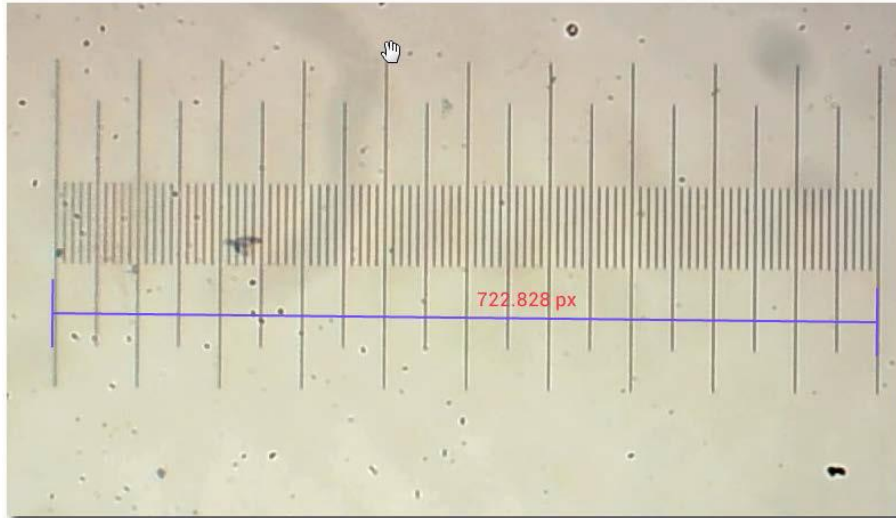

In the example shown, a scale with a fine division of 0.01 mm (10 μm) is used. The total length is 1000 μm

- Enter an appropriate name for the calibration.  
Usually the lens magnification set for the microscope is selected.  
In the example here: 4x.  
It is also vital to specify the length of the part as established using the scale, as well as the preferred measuring unit for the measurement.  
In the example here: 1000 μm.

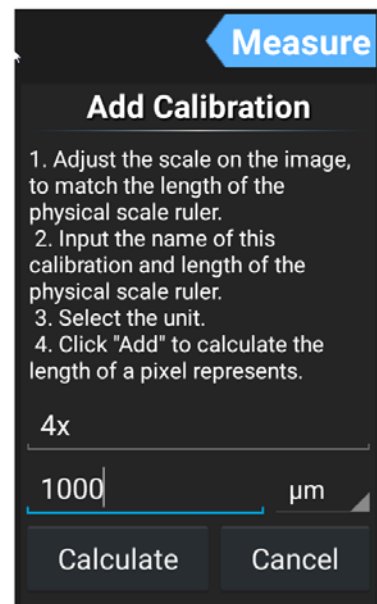















- Click on “Calculate” in order to save and close the calibration.  
This procedure must be carried out again for other lens magnifications.

Calibrations		
Name	Data	Unit
4x	1.3842217	μm
10x	0.10938032	μm

Buttons: Add, Edit, Delete

## Measuring tools:

Symbol	Function	Description
	Counting	Adding points which are marked with the consecutive numbers
	Line	Measuring the distance between two points
	Rectangle	Measuring the length, width and area of a rectangle
	Circle	Measuring the radius and area of a circle <i>Different methods are available for creating a circule</i>
	Cross line	Adding a cross line <i>Multiple x or y axes possible</i>
	Angle	Measuring an angle
	Double circle	Measuring the distance between two circle centres
	Perpendicular	Measuring the distance between a line and a point
	Concentricity	Measuring the radii of two circles with the same centre
	Text	Adding text annotations
	Settings	Setting the line thickness, line colour, font and font size and colour
	Save	Creating an image which contains the currently displayed measurements
	Delete 1	Delete one selected measurement
	Delete 2	Delete all measurements on the screen

**Example of a line measurement:**

1. Select a saved calibration under the “Measure” program category.

It is selected when you see white background with black text.

Calibrations		
Name	Data	Unit
4x	1.3842217	μm
10x	0.10938032	μm

Add Edit Delete

2. Click on the symbol for line measurement.

Then the measuring line along with the measurements will be displayed in the live image transfer. This can be moved as required and the length can be altered.

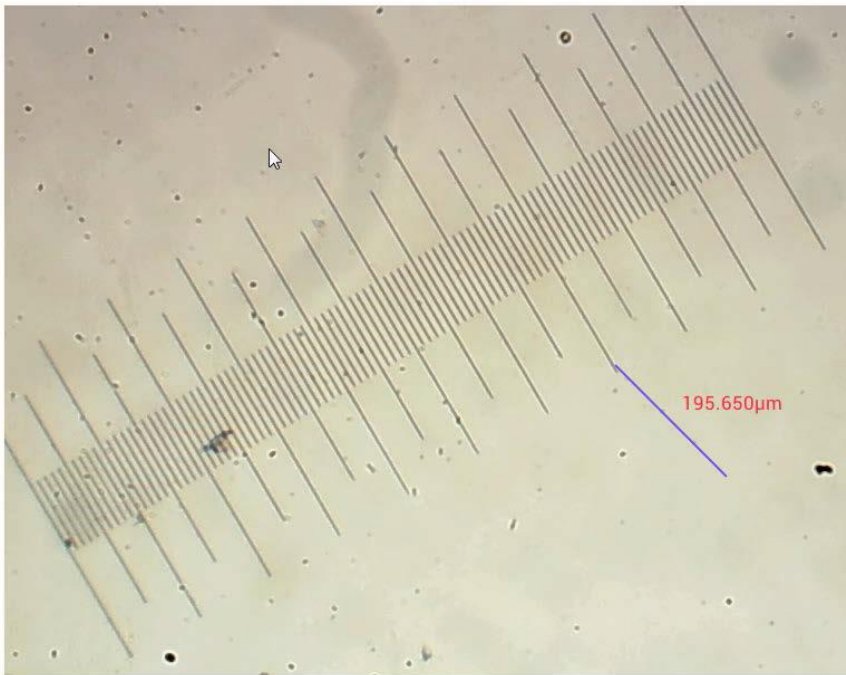

### 5.3.5 Image analysis

The built-in image display program offers the user various options for image analysis. In order to be able to use this tool, it must first be activated in the “Setting” program category.

→ Tick the box for “Enable built-in image viewer”

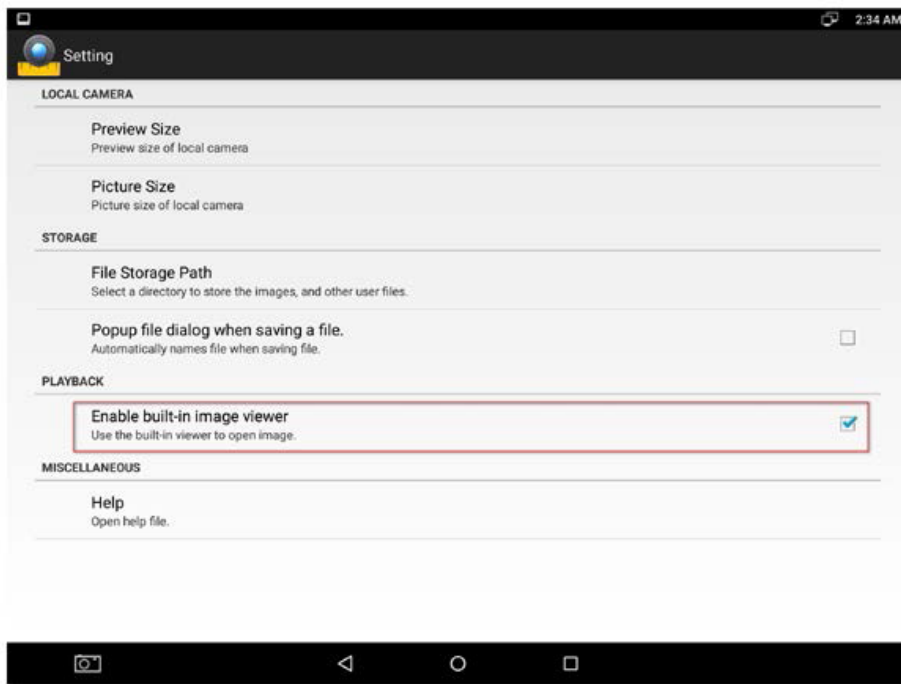

As soon as an image is opened in the “Playback” program category, this is then displayed on the S-EYE image display.

Further images can be opened here or new images can be captured at this point.

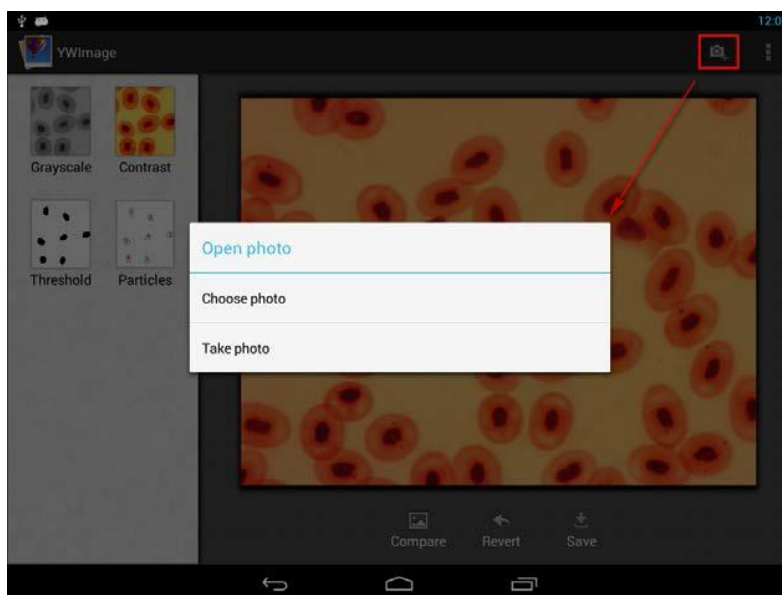

Four different instruments for image processing or image analysis can be implement with this program:

1. **Greyscale**  
“GREYSCALE” function

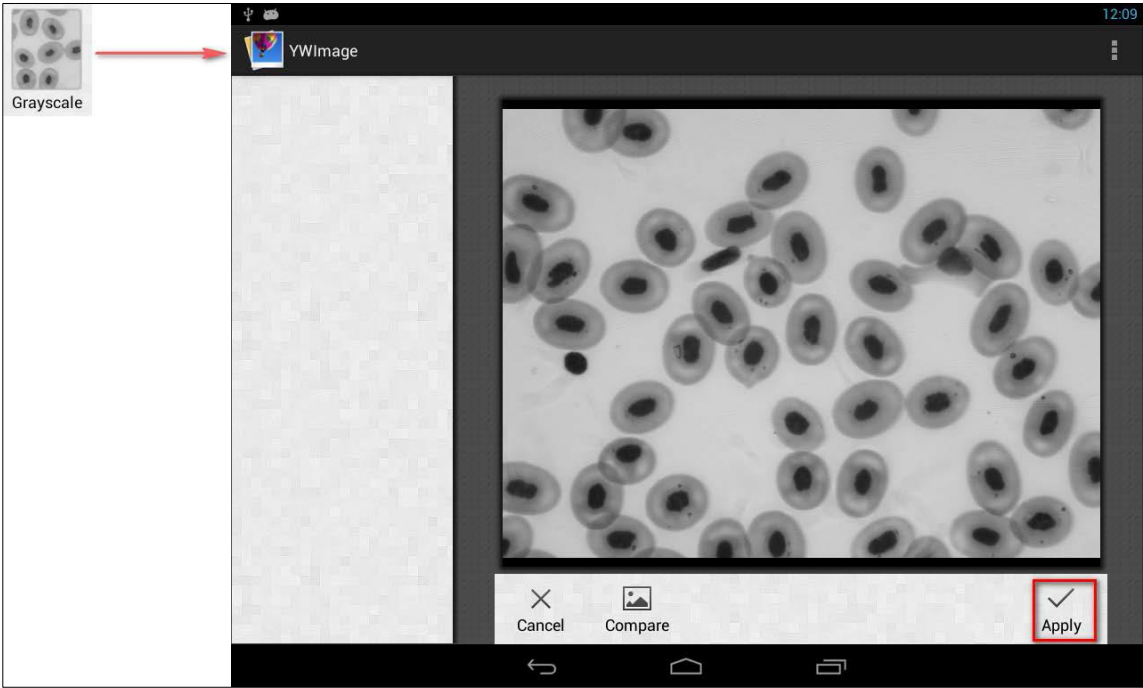

2. **Contrast and brightness**  
“CONTRAST” function

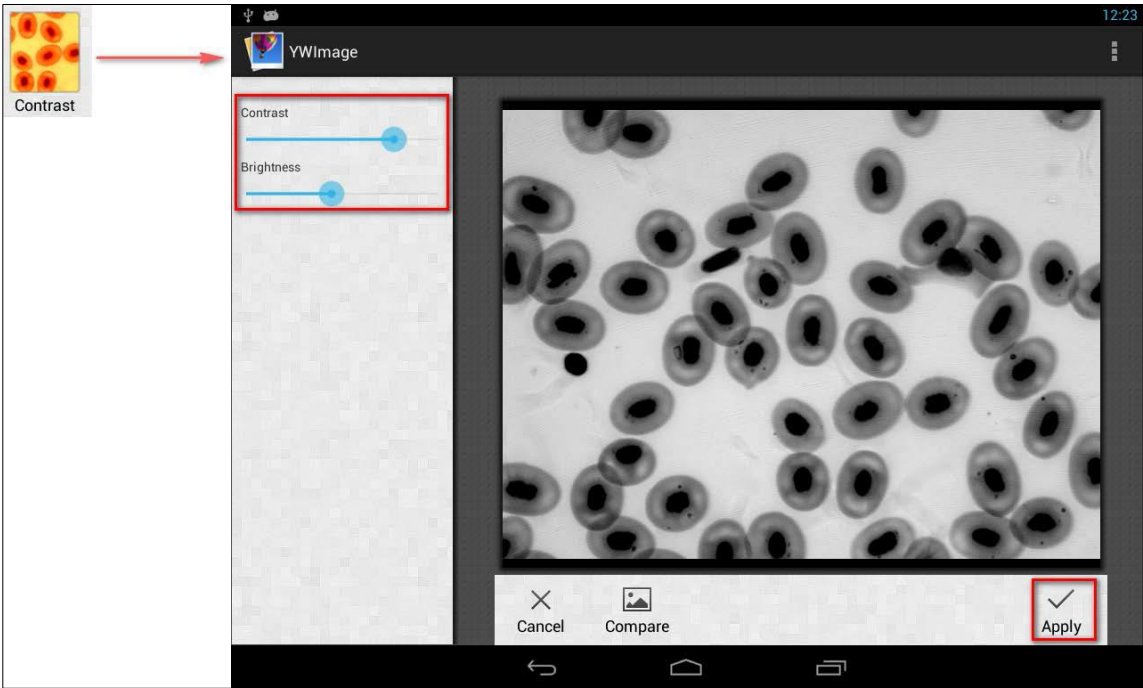



### 3. Threshold "THRESHOLD" function

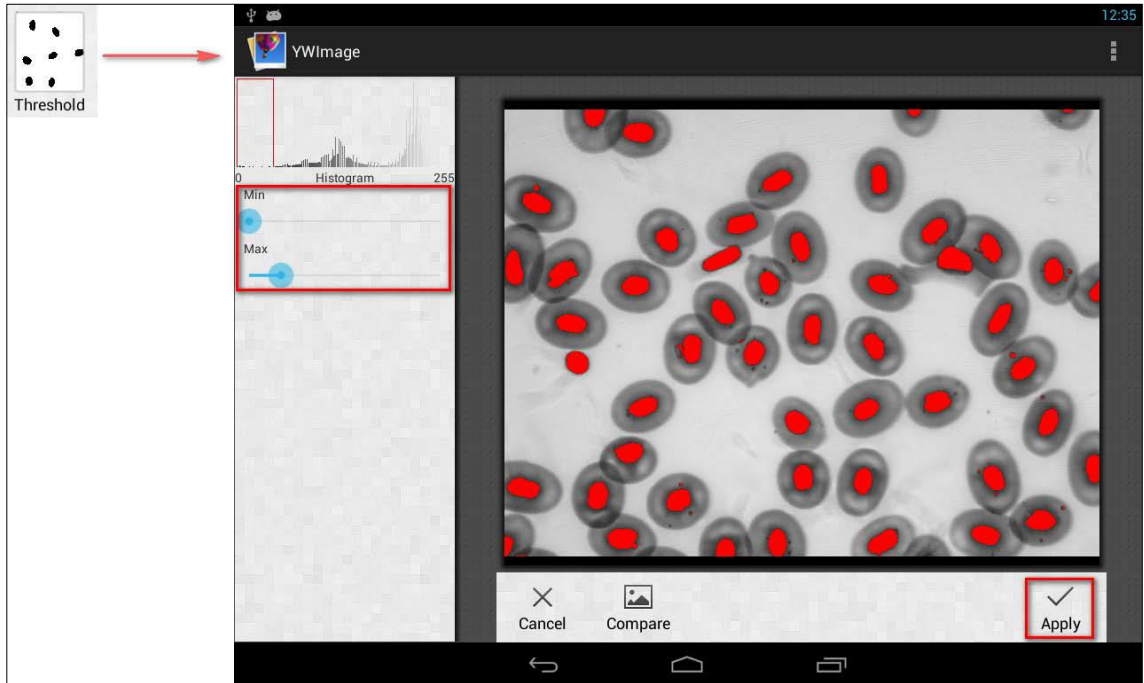

### 4. Particle analysis "PARTICLES" function

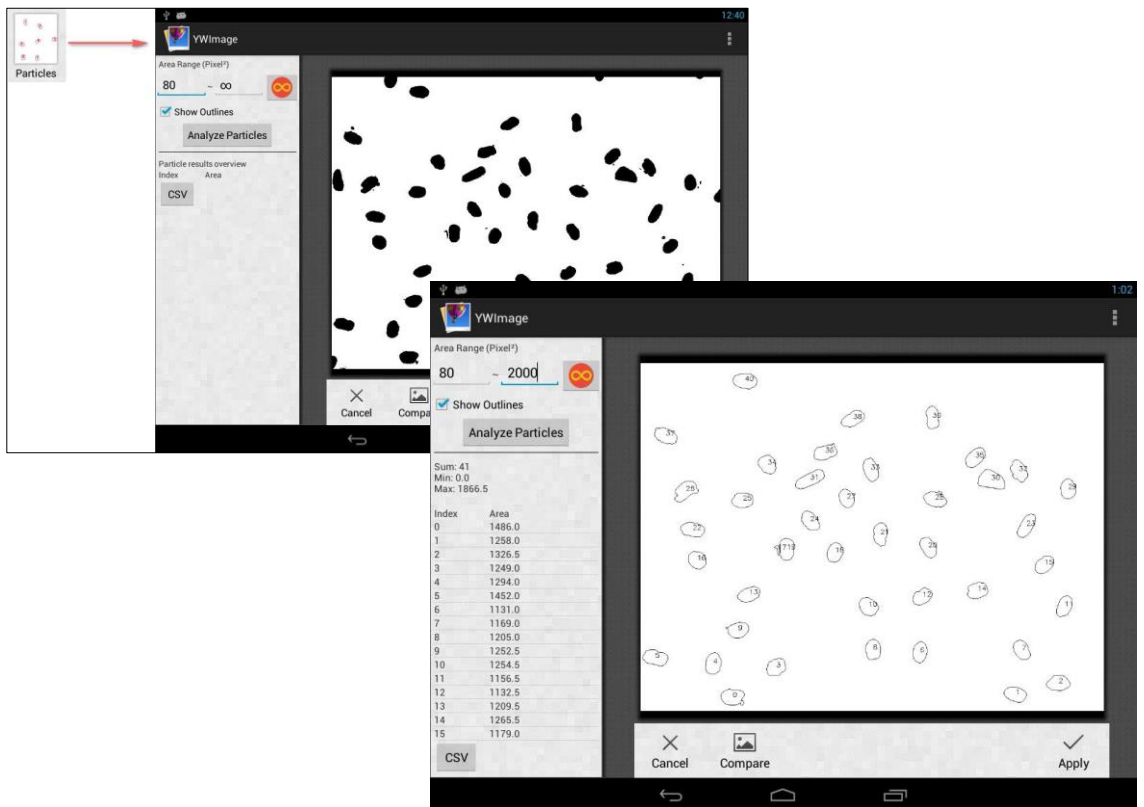

## 6 Service

If, after studying the user manual, you still have questions about commissioning or using the microscope, or if unforeseen problems should arise, please get in touch with your dealer. The device may only be opened by trained service engineers who have been authorised by KERN.

## 7 Disposal

The packaging is made of environmentally-friendly materials, which you can dispose of at your local recycling centre. Disposal of the storage box and device must be carried out by the operator in accordance with all national or regional laws in force in the location of use.

## 8 Further information

The illustrations may differ slightly from the product.

The descriptions and illustrations in this user manual are subject to change without notice. Further developments on the device may lead to these changes.



All language versions contain a non-binding translation.  
The original German document is the binding version.