



KERN & Sohn GmbH

Ziegelei 1  
72336 Balingen-Frommern  
Germany

[www.kern-sohn.com](http://www.kern-sohn.com)

+0049-[0]7433-9933-0

+0049-[0]7433-9933-149

[info@kern-sohn.com](mailto:info@kern-sohn.com)

# Operating and Installation Instructions Display units

## KERN KFC-TM Type TKFC-TM-C

Version 1.0

2023-08

GB



TKFC-TM-C-BA\_IA-e-2310



# KERN KFC-TM

Version 1.0 2023-08

## Operating and Installation Instructions Display units

---

---

### Content

1	Technical data.....	5
2	Declaration of conformity .....	6
3	Appliance overview .....	7
3.1	Components .....	7
3.2	Operating elements .....	8
3.2.1	Keyboard overview.....	8
3.2.2	Numerical input .....	9
3.2.3	Overview of displays .....	10
4	Basic Information (General) .....	11
4.1	Proper use .....	11
4.2	Improper Use.....	11
4.3	Warranty.....	11
4.4	Monitoring of Test Resources.....	12
5	Basic Safety Precautions .....	12
5.1	Pay attention to the instructions in the Operation Manual .....	12
5.1	Personnel training.....	12
6	Transport and storage.....	12
6.1	Testing upon acceptance .....	12
6.1	Packaging / return transport .....	12
7	Unpacking, Installation and Commissioning.....	13
7.1	Installation Site, Location of Use .....	13
7.2	Unpacking and checking .....	14
7.3	Mains connection.....	14
7.4	Rechargeable battery operation (optional) .....	15
7.4.1	Load rechargeable battery .....	15
7.5	Connection of peripheral devices .....	16
7.6	Initial Commissioning.....	16
7.7	Adjustment .....	16
7.7.1	External adjustment < RLEH > .....	17

7.7.2	External adjustment with user-defined adjustment weight < cALEdud >.....	18
7.7.3	Gravitational constant adjustment location < GrADdJ >.....	20
7.7.4	Gravitational constant place of location < GrAdbE >.....	21
8	Verification .....	22
9	Basic Operation .....	24
9.1	Turn on/off .....	24
9.2	Simple weighing .....	24
9.3	Zeroing .....	25
9.4	Taring .....	25
9.5	Change-over button and F button (standard settings) .....	26
9.5.1	Switch-over weighing unit.....	27
9.5.2	Display gross weight value.....	28
9.5.3	Open PRE-Tare settings .....	28
9.5.4	Carry out Data-Hold function.....	28
10	Operating concept .....	29
11	Application <Weighing> .....	31
11.1	Application-specific settings .....	31
11.2	PRE-Tare .....	33
11.2.1	Take over the placed weight as PRE-TARE value.....	33
11.2.2	Enter the known tare weight numerically .....	34
11.3	Data-Hold function .....	34
11.4	Weighing Units.....	35
11.4.1	Setting weighing unit.....	35
11.4.2	Weighing with multiplication factor via the application unit <FFA>.....	36
11.4.3	Percent weighing by application unit <%> .....	36
12	Application <Counting>.....	37
12.1	Application-specific settings .....	37
12.2	Using the application.....	38
12.2.1	Piece counting.....	38
12.2.2	Target counting .....	41
13	Application < Checkweighing >.....	44
13.1	Application-specific settings .....	44
13.2	Using the application.....	45
13.2.1	Target weighing.....	45
13.2.2	Checkweighing.....	48
14	Menu.....	50
14.1	Navigation in the menu.....	50

14.2	Application menu.....	50
14.3	Setup menu.....	51
14.3.1	Overview < ኃይሎቅ > .....	51
15	Communication with peripheral devices .....	63
15.1	KERN Communications Protocol (KERN Interface Protocol) .....	63
15.2	KERN alibi memory.....	64
15.3	Issue functions .....	65
15.3.1	Add-up mode < ኃህብ >.....	65
15.3.2	Data output after pressing the PRINT button < ባለገህባሊ >.....	67
15.3.3	Automatic data output < ባህሎ > .....	68
15.3.4	Continuous data output < ርገሎ >.....	68
15.4	Data format .....	69
16	Servicing, maintenance, disposal .....	70
16.1	Cleaning.....	70
16.2	Servicing, maintenance .....	70
16.3	Disposal .....	70
17	Instant help for troubleshooting.....	71
18	Error messages .....	72

## 1 Technical data

KERN	KFC-TM
Item no./ Type	TKFC-TM-C
Display	LCD 6 digits, height 50 mm with back lighting
Resolution (verifiable)	Single (Max.) 3000 e
	Multi Range/Multi Intervall (Max.) 2x3000 e
Resolution (non-verifiable)	30.000 d
Verification class	III
Weighing ranges	2
Divisions	1,2,5,10, n
DMS weighing cells	87-1100 $\Omega$ . (minimum/maximum resistance)
Applications	Weighing, Counting, Checkweighing
Weighing Units	g, kg, lb, pcs, %, FFA
Allowable ambient temperature	-10 °C ... + 40 °C
Operating temperature range with the rechargeable battery	0 °C ... + 40 °C
Electric Supply	Input voltage Mains adapter 110 V – 240 V
	Input voltage Appliance 6 V, 1 A
Storage battery operation (optional)	Operating time 48 hrs (backlight off) Operating time 20 hrs (backlight on) Loading time approx. 8 hrs.
Dimensions display unit	220 x 145 x 65 (L x W x H) [mm]
Net weight (kg)	0,8
Interfaces	RS-232, USB-Device, WiFi, Analogue (0-10V, 4-20mA), Ethernet, Bluetooth via KUP (factory option)
Altitude	Below 2000 m

**\* Smallest part weight for piece counting - under lab conditions:**

- There are ideal ambient conditions for high-resolution counting
- The parts to be counted are not scattered

**\*\* Smallest part weight for piece counting - under normal conditions:**

- There are unsteady ambient conditions (draft, vibrations)
- The parts to be counted are being scattered

**2 Declaration of conformity**

The current EC/EU Conformity declaration can be found online in:

**[www.kern-sohn.com/ce](http://www.kern-sohn.com/ce)**

### 3 Appliance overview

#### 3.1 Components

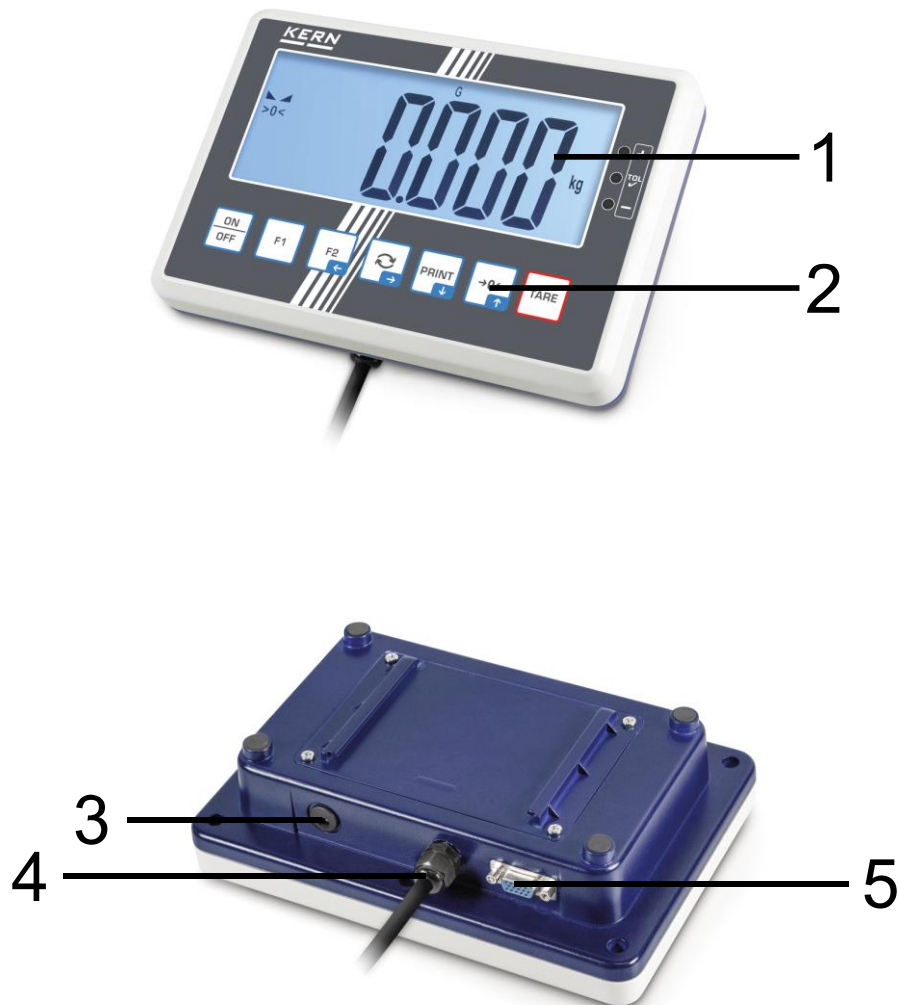

Pos.	Designation
------	-------------

- |   |                                      |
|---|--------------------------------------|
| 1 | Display                              |
| 2 | Keyboard                             |
| 3 | Mains adapter connection             |
| 4 | Input connection load cell cable     |
| 5 | KUP connection (KERN Universal Port) |

## 3.2 Operating elements

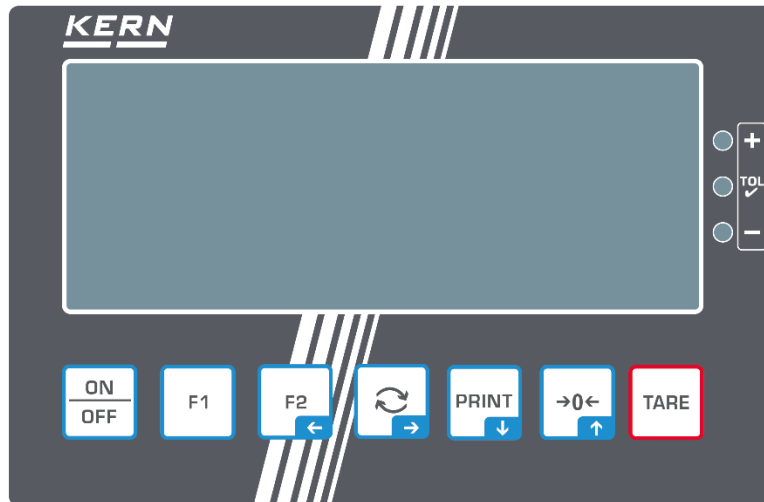



### 3.2.1 Keyboard overview

Button	Name	Function in Operating mode	Function in Menu
	ON/OFF-button	<ul style="list-style-type: none"> <li>➤ Switch on/off (press button long time)</li> <li>➤ Switch on/off the display background illumination (press button short time)</li> </ul>	
	F1-key	<ul style="list-style-type: none"> <li>➤ Functions key, see chap. 9.5</li> </ul>	
	F2-key	<ul style="list-style-type: none"> <li>➤ Functions key, see chap. 9.5</li> </ul>	<ul style="list-style-type: none"> <li>➤ Navigation key ←</li> <li>➤ Menu level back</li> <li>➤ Exit menu / back to weighing mode.</li> </ul>
	↻key	<ul style="list-style-type: none"> <li>➤ Change-over button, see chap. 9.5</li> </ul>	<ul style="list-style-type: none"> <li>➤ Navigation key →</li> <li>➤ Activate menu item</li> <li>➤ Confirm selection</li> </ul>
	PRINT-button	<ul style="list-style-type: none"> <li>➤ Calculate weighing data via interface</li> <li>➤ Display increased resolution (long keystroke, only for verified scales)</li> </ul>	<ul style="list-style-type: none"> <li>➤ Navigation key ↓</li> <li>➤ Select menu item</li> </ul>
	ZERO-key	<ul style="list-style-type: none"> <li>➤ Zeroing</li> </ul>	<ul style="list-style-type: none"> <li>➤ Navigation key ↑</li> <li>➤ Select menu item</li> </ul>
	TARE-button	<ul style="list-style-type: none"> <li>➤ Taring</li> </ul>	<ul style="list-style-type: none"> <li>➤ Invoke application menu (press button long time)</li> </ul>



### 3.2.2 Numerical input

Button	Designation	Function
	Navigation key →	Select cipher Confirm entry. Press button repeatedly for every digit. Wait until the numeric input window extinguishes.
	Navigation key ↓	Reduce flashing cipher (0 – 9)
	Navigation key ↑	Increase flashing cipher (0 – 9)

### 3.2.3 Overview of displays

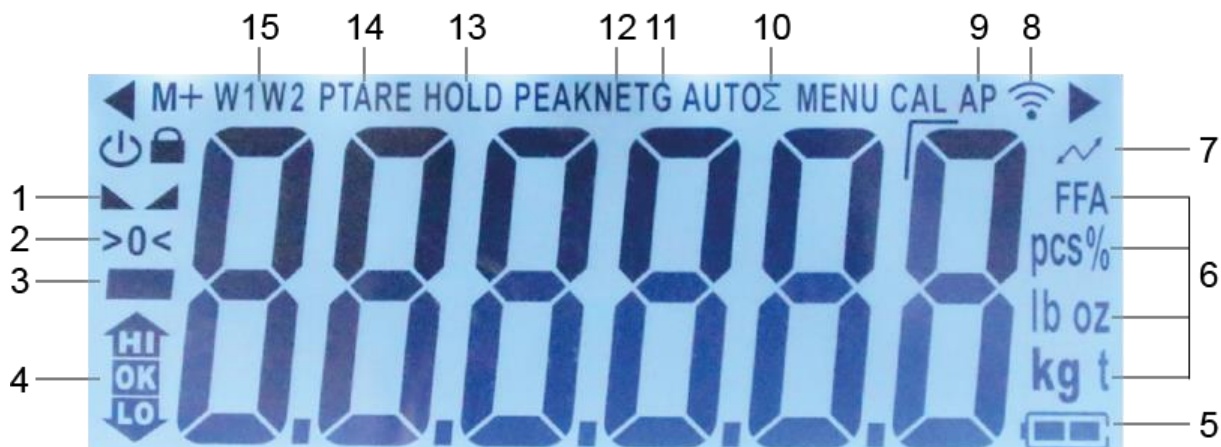

Position	Display	Description
1		Stability display
2	>0<	Zero display
3		Minus display
4		Tolerance marks for check weighing
5		Rechargeable battery charge indicator
6	Units display / Pcs/ %	options g, kg, lb, gn, oz or Application icon [ <b>Pcs</b> ] for piece counting or [%] for determination of percentage
7		Data transfer running
8		WIFI-symbol
9	AP	Autoprint enabled
10	Σ	Weighing data can be found in the sum memory
11	G	Display gross weight value
12	NET	Display net weight value
13	HOLD	Hold/ animal weighing function
14	PTARE	Pre-Tare function
15	W1W2	Display of selected weighing range

## **4 Basic Information (General)**

### **4.1 Proper use**

The balance you purchased is intended to determine the weighing value of material to be weighed. It is intended to be used as a “non-automatic balance”, i.e. the material to be weighed is manually and carefully placed in the centre of the weighing plate. As soon as a stable weighing value is reached, the weighing value can be read.

### **4.2 Improper Use**

- Our balances are non-automatic balances and not provided for use in dynamic weighing processes. However, the balances can also be used for dynamic weighing processes after verifying their individual operative range, and here especially the accuracy requirements of the application.
- Do not leave permanent load on the weighing plate. This may damage the measuring system.
- Impacts and overloading exceeding the stated maximum load (max) of the balance, minus a possibly existing tare load, must be strictly avoided. Balance may be damaged by this.
- Never operate the balance in explosive environment. The serial version is not explosion protected.
- The structure of the balance may not be modified. This may lead to incorrect weighing results, safety-related faults and destruction of the balance.
- The balance may only be used according to the described conditions. Other areas of use must be released by KERN in writing.

### **4.3 Warranty**

Warranty claims shall be voided in case:

- Our conditions in the operation manual are ignored
- The appliance is used beyond the described uses
- The appliance is modified or opened
- Mechanical damage or damage by media, liquids, natural wear and tear
- The appliance is improperly set up or incorrectly electrically connected
- The measuring system is overloaded

## 4.4 Monitoring of Test Resources

In the framework of quality assurance the measuring-related properties of the balance and, if applicable, the testing weight, must be checked regularly. The responsible user must define a suitable interval as well as type and scope of this test. Information is available on KERN's home page ([www.kern-sohn.com](http://www.kern-sohn.com)) with regard to the monitoring of balance test substances and the test weights required for this. In KERN's accredited calibration laboratory test weights and balances may be calibrated (return to the national standard) fast and at moderate cost.

## 5 Basic Safety Precautions

### 5.1 Pay attention to the instructions in the Operation Manual



⇒ Carefully read this operation manual before setup and commissioning, even if you are already familiar with KERN balances.

### 5.1 Personnel training

The appliance may only be operated and maintained by trained staff.

## 6 Transport and storage

### 6.1 Testing upon acceptance

When receiving the appliance, please check packaging immediately, and the appliance itself when unpacking for possible visible damage.

### 6.1 Packaging / return transport



- ⇒ Keep all parts of the original packaging for a possibly required return.
- ⇒ Only use original packaging for returning.
- ⇒ Prior to dispatch disconnect all cables and remove loose/mobile parts.
- ⇒ Reattach possibly supplied transport securing devices.
- ⇒ Secure all parts such as the wind screen, the weighing plate, power supply unit etc. against shifting and damage.

## **7 Unpacking, Installation and Commissioning**

### **7.1 Installation Site, Location of Use**

The balances are designed in a way that reliable weighing results are achieved in common conditions of use.

You will work accurately and fast, if you select the right location for your balance.

#### **On the installation site observe the following:**

- Place the balance on a firm, level surface.
- Avoid extreme heat as well as temperature fluctuation caused by installing next to a radiator or in the direct sunlight.
- Protect the balance against direct draughts due to open windows and doors.
- Avoid jarring during weighing.
- Do not expose the device to extreme dampness for longer periods of time. Non-permitted condensation (condensation of air humidity on the appliance) may occur if a cold appliance is taken to a considerably warmer environment. In this case, acclimatize the disconnected appliance for ca. 2 hours at room temperature.
- Avoid static charge of goods to be weighed or weighing container.
- Do not operate in areas with hazard of explosive material or in potentially explosive atmospheres due to materials such as gasses, steams, mists or dusts.
- Keep away chemicals (such as liquids or gasses), which could attack and damage the balance inside or from outside.
- Keep IP protection of the device.
- In the event of the occurrence of electromagnetic fields, static charges (e.g., when weighing / counting plastic parts) and unstable power supply, large display deviations (incorrect weighing results, as well as damage to the scale) are possible. Change location or remove source of interference.

## 7.2 Unpacking and checking

Remove device and accessories from packaging, remove packaging material and install the device at the planned workplace. Check if that there has been no damage and that all items of delivery scope are present.

Scope of delivery / serial accessories:

- Display Unit
- Mains adapter
- Support base incl. wall bracket
- Operating instructions

## 7.3 Mains connection



Select a country-specific power plug and insert it in the mains adapter.



Check, whether the voltage acceptance on the scales is set correctly. Do not connect the scales to the power mains unless the information on the scales (sticker) matches the local mains voltage.



Only use KERN original mains adapter. Using other makes requires consent by KERN.



### **Important:**

- Before starting your weighing balance, check the mains cable for damage.
- Ensure that the power unit does not come into contact with liquids.
- Ensure access to mains plug at all times.

## 7.4 Rechargeable battery operation (optional)

<p><b>ATTENTION</b></p>   	<ul style="list-style-type: none"> <li>⇒ The rechargeable battery and the battery match with each other. Only use the delivered mains adapter.</li> <li>⇒ Do not use the balance during the loading process.</li> <li>⇒ The rechargeable battery can only be replaced by the same or by a type recommended by the manufacturer.</li> <li>⇒ The rechargeable battery is not protected against all environmental influences. If the rechargeable battery is exposed to certain environmental influences, it may set on fire or explode. Persons may be injured or material damage may occur.</li> <li>⇒ Protect the rechargeable battery against fire and heat.</li> <li>⇒ Do not bring the rechargeable battery in contact with fluids, chemical substances or salt.</li> <li>⇒ Do not expose the rechargeable battery to high pressure or microwaves.</li> <li>⇒ Under no circumstances the rechargeable batteries and the charging unit may be modified or manipulated.</li> <li>⇒ Do not use a defective, damaged or deformed rechargeable battery.</li> <li>⇒ Do not connect or short-circuit the electrical contacts of the rechargeable battery with metallic objects.</li> <li>⇒ Liquid may squirt out from a damaged rechargeable battery. If the liquid gets into contact with the skin or the eyes, the skin and the eyes may be irritated.</li> <li>⇒ Ensure the correct polarity when inserting or changing the rechargeable battery (see instructions in the battery compartment)</li> <li>⇒ The rechargeable battery operation is overridden when the mains adapter is connected. For weighing in mains operation &gt; 48 hrs. the rechargeable batteries must be removed! (Danger of overheating).</li> <li>⇒ If the rechargeable battery starts to smell, being hot, changing the colour or being deformed, it must be immediately unplugged from mains supply and from the balance if possible.</li> </ul>
---	--

### 7.4.1 Load rechargeable battery

Before the first use, the rechargeable battery package should be charged for at least 15 hours.

To save the rechargeable battery, in menu (see chap. 14.3.1) the automatic switch-off function <  $\overline{A} \overline{U} \overline{E} \square \overline{F} \overline{F}$  > can be activated.

If the capacity of the rechargeable batteries is exhausted, <  $\overline{L} \square \overline{b} \overline{A} \overline{E}$  > appears in the display. Connect the power cable as soon as possible to load the rechargeable battery. Charging time until complete recharging is approx. 8 hrs.

## 7.5 Connection of peripheral devices

Before connecting or disconnecting of additional devices (printer, PC) to the data interface, always disconnect the balance from the power supply.

With your balance, only use accessories and peripheral devices by KERN, as they are ideally tuned to your balance.

## 7.6 Initial Commissioning

In order to obtain exact results with the electronic balances, your balance must have reached the operating temperature (see warming up time chap. 1). During this warming up time the balance must be connected to the power supply (mains, rechargeable accumulator or battery).

The accuracy of the balance depends on the local acceleration of gravity.

Strictly observe hints in chapter Adjustment.

## 7.7 Adjustment

As the acceleration value due to gravity is not the same at every location on earth, each balance must be coordinated - in compliance with the underlying physical weighing principle - to the existing acceleration due to gravity at its place of location (only if the balance has not already been adjusted to the location in the factory). This adjustment process must be carried out for the first commissioning, after each change of location as well as in case of fluctuating environment temperature. To receive accurate measuring values it is also recommended to adjust the balance periodically in weighing operation.



- Prepare the required adjustment weight, see chap. 1. The adjustment weight to be applied depends on the capacity of a weighing scale. Carry out adjustment as closely as possible to admissible maximum load of weighing scale. Info about test weights can be found on the Internet at: <http://www.kern-sohn.com>.
- Observe stable environmental conditions. A warm up time (see chapter 1) is required for stabilization.
- Ensure that there are no objects on the weighing plate.
- Avoid vibration and air flow.
- Always carry out adjustment with the standard weighing plate in place.

The adjustment is locked in weighing scales with type approval certificate.

To disable the access lock, destroy the seal mark and actuate the adjustment switch. Position of the adjustment switch, see chap. 8.

- **Attention:**

After destruction of the seal the balance must be re-verified by an authorised agency and a new verification wire/seal mark fitted before it can be reused for applications subject to verification.



### 7.7.1 External adjustment < cALeHt >

⇒ Press and hold the TARE and ON/OFF buttons simultaneously to enter the setup menu.

⇒ Wait until the first menu item < cAL > is displayed.

⇒ Confirm by → button, < cALeHt > will be displayed.

⇒ Confirm by pressing the → button, the first selectable adjustment weight is displayed.

⇒ Use the navigation keys ↓↑ to select the desired adjustment weight, see chap. 1 „Adjustment points“ or „Recommended adjustment weight“

⇒ Prepare the required adjustment weight.

⇒ Acknowledge selection by → button. < Zero >, < PutLd > followed by the weight value of the adjustment weight to be placed will be displayed.

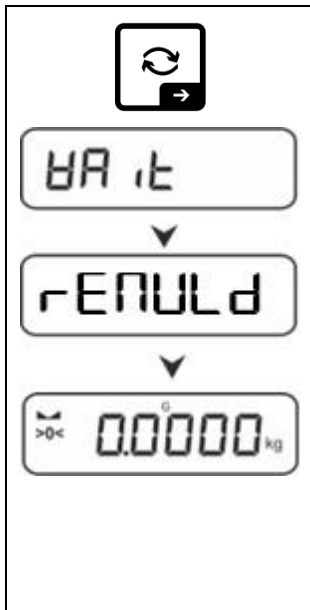

⇒ Place the adjustment weight and confirm with → button, < HARt > followed by < rENULd > will be displayed.

⇒ Once < rENULd > is displayed, remove the adjustment weight.

⇒ After successful adjustment the balance automatically returns to weighing mode. In case of an adjustment error (e.g. objects on the weighing plate) the display will show the error message < HrOnG >. Switch off balance and repeat the adjustment process.

### 7.7.2 External adjustment with user-defined adjustment weight < cAL Eud >

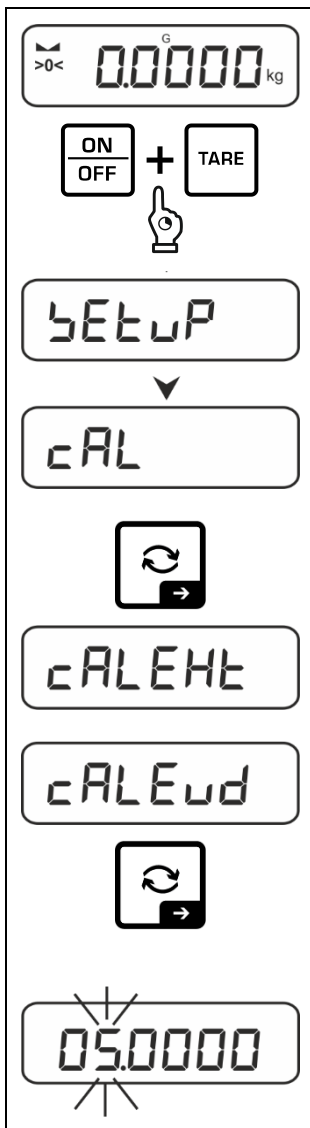

⇒ Press and hold the TARE and ON/OFF buttons simultaneously to enter the setup menu.

⇒ Wait until the first menu item < cAL > is displayed.

⇒ Confirm by → button, < cALEHt > will be displayed.

⇒ Use the navigation keys to select ↓ ↑ < cALEud >.

⇒ Acknowledge by → button. The numeric input window for the weight value of the adjustment weight appears. The active digit is flashing.

⇒ Provide adjustment weight.

⇒ Enter weight value, numerical input see chap. 3.2.2

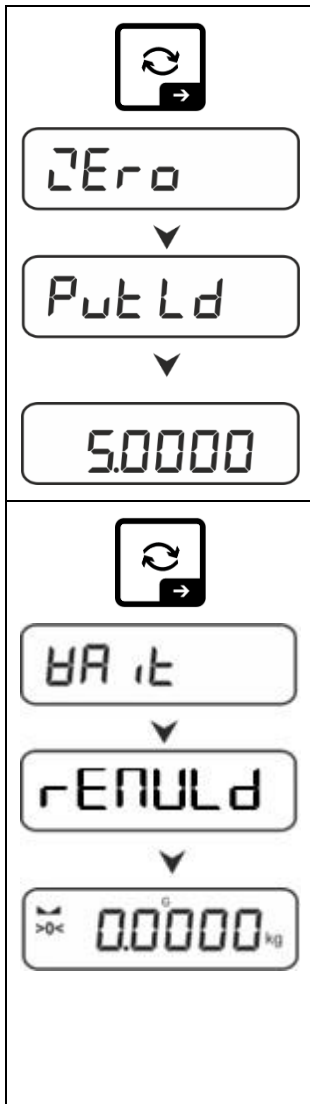









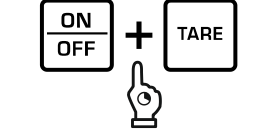

⇒ Acknowledge selection by → button. <Zero>, <Put Ld> followed by the weight value of the adjustment weight to be placed will be displayed.

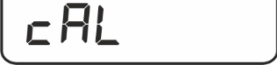
⇒ Place the adjustment weight and confirm with → button, <Hr It> followed by <rENULd> will be displayed.

⇒ Once <rENULd> is displayed, remove the adjustment weight.

⇒ After successful adjustment the balance automatically returns to weighing mode.  
In case of an adjustment error (e.g. objects on the weighing plate) the display will show the error message <ErrOnG>. Switch off balance and repeat the adjustment process.

### 7.7.3 Gravitational constant adjustment location < GrAADJ >

	<p>⇒ Press and hold the TARE and ON/OFF buttons simultaneously to enter the setup menu.</p>
	
	
	
	<p>⇒ Wait until the first menu item &lt; CAL &gt; is displayed.</p>
	<p>⇒ Confirm by → button, &lt; CAL EHT &gt; will be displayed.</p>
	
	<p>⇒ Use the navigation keys to select ↓ ↑ &lt; GrAADJ &gt;.</p>
	<p>⇒ Acknowledge using → button, the current setting is displayed. The active digit is flashing.</p>
	<p>⇒ Enter weight value and confirm using the → button, numerical input see chap. see chap. 3.2.2. Weighing balance returns to menu.</p>
	
	
	<p>⇒ Press repeatedly ← button to exit menu.</p>

### 7.7.4 Gravitational constant place of location < GrAuSE >

	<p>⇒ Press and hold the TARE and ON/OFF buttons simultaneously to enter the setup menu.</p>
	<p>⇒ Wait until the first menu item &lt; CAL &gt; is displayed.</p>
	<p>⇒ Confirm by → button, &lt; CALHE &gt; will be displayed.</p>
	<p>⇒ Use the navigation keys to select ↓ ↑ &lt; GrAuSE &gt;.</p>
	<p>⇒ Acknowledge using → button, the current setting is displayed. The active digit is flashing.</p>
	<p>⇒ Enter weight value and confirm using the → button, numerical input see chap. 3.2.2. Weighing balance returns to menu.</p>
	<p>⇒ Press repeatedly ← button to exit menu.</p>

## 8 Verification

### General:

According to EU directive 2014/31/EU balances must be officially verified if they are used as follows (legally controlled area):

- For commercial transactions if the price of goods is determined by weighing.
- For the production of medicines in pharmacies as well as for analyses in the medical and pharmaceutical laboratory.
- For official purposes
- For manufacturing final packages

In cases of doubt, please contact your local trade in standard.

Balances in the legally controlled area (-> verified balances) must keep the error limits in the verification validity period – normally they are the double of the verification error limits.

When this verification validity period expires, a re-verification must be carried out. Should be necessary an adjustment of the balance to keep the verification error limits to satisfy the re-verification requirements, this is not deemed a warranty case.

### Verification notes:

An EU type approval exists for balances described in their technical data as verifiable. If the balance is used where obligation to verify exists as described above, it must be verified and re-verified at regular intervals.

Re-verification of a balance is carried out according to the respective national regulations. The validity for verification of balances in Germany is e.g. 2 years.

The legal regulation of the country where the balance is used must be observed!



#### **Verification of the balance is invalid without the seal.**

The seal marks attached on balances with type approval point out that the balance may only be opened and serviced by trained and authorised specialist staff. If the seal mark is destroyed, verification loses its validity. Please observe all national laws and legal regulations. In Germany a re-verification will be necessary.

**Position of the official seals:**

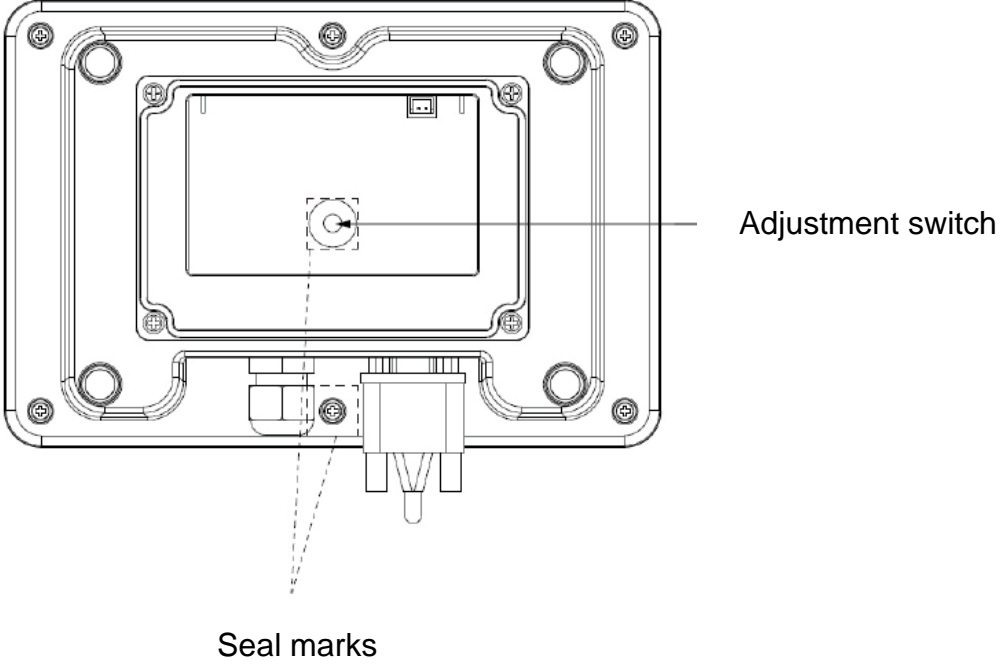

## 9 Basic Operation

### 9.1 Turn on/off

Start-up:

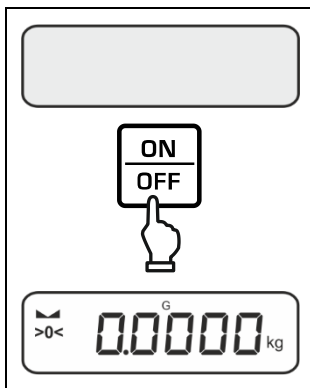

- ⇒ Press the **ON/OFF** button.  
The display lights up and the balance carries out a self-test.  
Wait until the weight display appears  
The scales are now ready for operation using the last active application

Switching off:

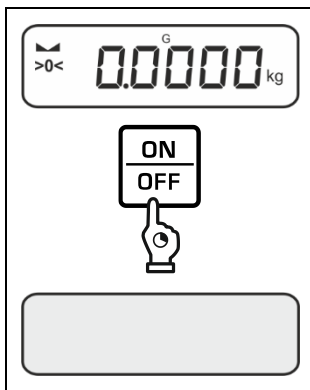

- ⇒ Keep **ON/OFF** button pressed until the display disappears

### 9.2 Simple weighing



- ⇒ Check zero display [**>0<**] and set to zero with the help of the **ZERO** key, as required.
- ⇒ Place goods to be weighed on balance
- ⇒ Wait until the stability display appears (  ).
- ⇒ Read weighing result.



#### Overload warning

Overloading exceeding the stated maximum load (max) of the device, minus a possibly existing tare load, must be strictly avoided.  
This could damage the instrument.

Exceeding the maximum load is indicated by the display “”. Unload balance or reduce preload.



### 9.3 Zeroing

In order to obtain optimal weighing results, reset to zero the balance before weighing. Zeroing is only possible in the range  $\pm 2\%$  Max.

For values greater than  $\pm 2\%$  maximum the error message  $\langle \text{OL} \text{ } \text{HI} \text{ } \text{LE} \rangle$  is displayed

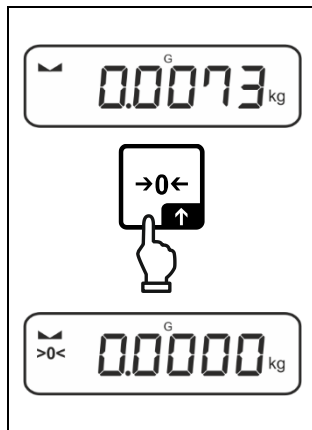

- ⇒ Unload the balance
- ⇒ Press the **ZERO** key to set the balance to zero.

### 9.4 Taring

The dead weight of any weighing container may be tared away by pressing a button, so that the following weighing procedures show the net weight of the goods to be weighed.

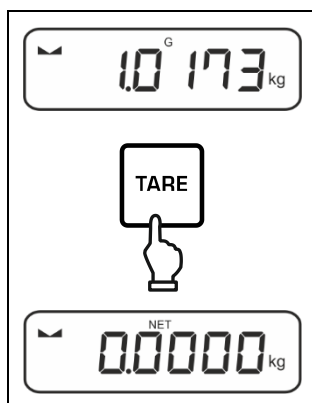

- ⇒ Put weighing container on the weighing plate.
- ⇒ Wait until the stability display appears (▲▲), then press **TARE** key. The weight of the container is now internally saved. Zero display and indicator **<NET>** will appear. **<NET>** informs that all shown weight values are net values.





- When the balance is unloaded the saved taring value is displayed with negative sign.
- To delete the stored tare value, unload the weighing plate and press the **TARE** key or the **ZERO** key.
- The taring process can be repeated any number of times, e.g. when adding several components for a mixture (adding). The limit is reached when the taring range capacity is full.
- Numerical input of tare (PRE-TARE)

## 9.5 Change-over button and F button (standard settings)

The change-over button  and the F button can be allocated with different functions.

The following functions are set as per standard (<DEFAULT>) in the different weighing applications:

	Short key pressing	Long key pressing
gROSS	<ul style="list-style-type: none"> <li>➤ When pressed for first time: Setting weighing unit</li> <li>➤ Switch-over between the weighing units</li> </ul>	<ul style="list-style-type: none"> <li>➤ Display gross weight value</li> </ul>
count	<ul style="list-style-type: none"> <li>➤ When pressed for first time: Setting the reference quantity</li> <li>➤ Switch-over between the weighing units</li> </ul>	<ul style="list-style-type: none"> <li>➤ When the balance has been tared and the weighing unit is displayed, you can change the display between gross weight, net weight and tare weight by pressing the button long time.</li> </ul>
check	<ul style="list-style-type: none"> <li>➤ When pressed for first time: Setting weighing unit</li> <li>➤ Switch-over between the weighing units</li> </ul>	<ul style="list-style-type: none"> <li>➤ When the balance has been tared and the weighing unit is displayed, you can change the display between gross weight, net weight and tare weight by pressing the button long time.</li> </ul>

	Short key pressing	Long key pressing
gROSS	<ul style="list-style-type: none"> <li>➤ Open PRE-TARE settings</li> </ul>	<ul style="list-style-type: none"> <li>➤ Carry out Data-Hold function</li> </ul>
count	<ul style="list-style-type: none"> <li>➤ Setting the reference quantity</li> </ul>	<b>No function assigned</b>
check	<ul style="list-style-type: none"> <li>➤ Open settings for check-weighing</li> </ul>	<ul style="list-style-type: none"> <li>➤ Open settings for target weighing</li> </ul>

	Short key pressing	Long key pressing
gROSS	<ul style="list-style-type: none"> <li>➤ Select application</li> </ul>	<b>No function assigned</b>
count		
check		

**i** For more setting options please see the setup menu under <button>, see chap. 14.3.1.

The standard settings (<DEFAULT>) for the <Weighing> application are described below.

### 9.5.1 Switch-over weighing unit

As per standard the change-over button  is set so that it is possible to switch-over between the weighing units by **shortly** pressing.

#### Enable unit:

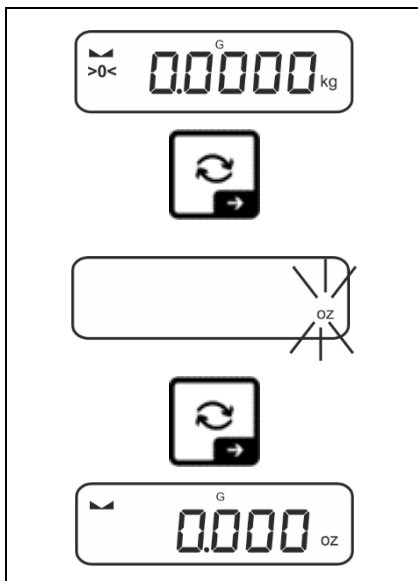



The unit for quick selection can be determined when the -button is shortly pressed for the first time.

⇒ Press the  button and wait until the display flashes.

⇒ Use the navigation keys ↓↑ to select the weighing unit and confirm on → button.

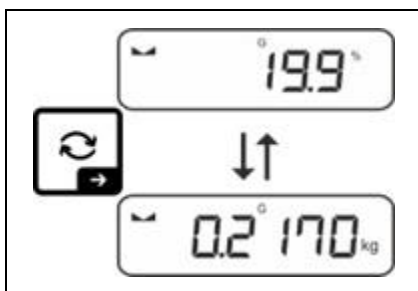
#### Switch over unit:



⇒ Using  button, it is possible to switch over between the enabled unit 1 and unit 2.

### Enable another unit:

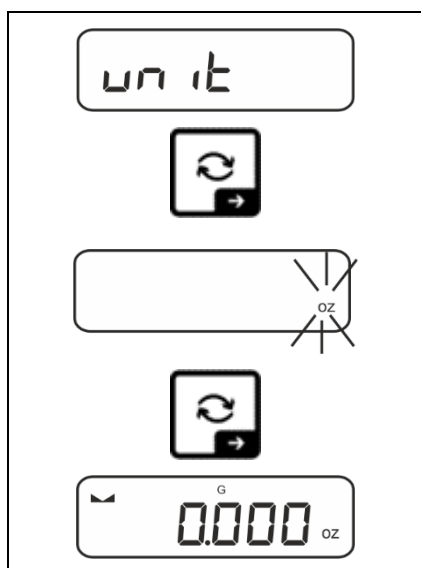

⇒ Select menu setting < unit > and confirm on → button.

⇒ Wait until the display flashes.

⇒ Use the navigation keys ↑ to select the weighing unit and confirm on → button.



For the required settings of an application unit (% , FFA) selection, please see chap. 11.4.2 and 11.4.3.

### 9.5.2 Display gross weight value

As per standard the change-over button  is set so that it is possible to display the gross weight value by long-time pressing.

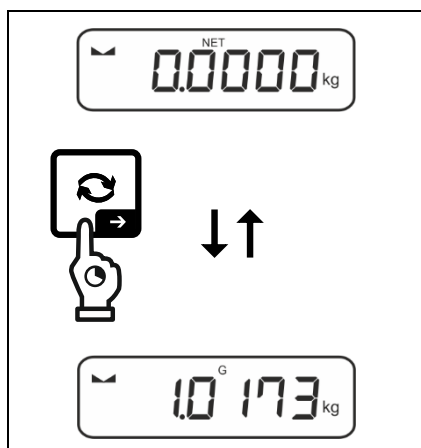

⇒ Keep the  button pressed until the display shows the gross weight value.

After releasing the button, the gross weight value will be kept in the display for a short time.

### 9.5.3 Open PRE-Tare settings

As per standard the F1-key is set so that the menu setting < PRE-TARE > is invoked by pressing the key **shortly**. Further settings, see chap. 11.2.

### 9.5.4 Carry out Data-Hold function

As per standard the F1-key is set so that the Data-Hold function < HOLD > is executed by pressing the key for a **long time**, see chap. 11.3.

## 10 Operating concept

From factory the balance is delivered with various applications (weighing, check weighing, counting). After the first start-up the balance is in the <Weighing> application.

In the **application menu** (see chap. 14.2) however, you can define, selecting an application, in which mode the balance after switching-on has to continue working. Either as per standard in weighing mode or e.g. in check mode or counting mode.

### Selecting an application:

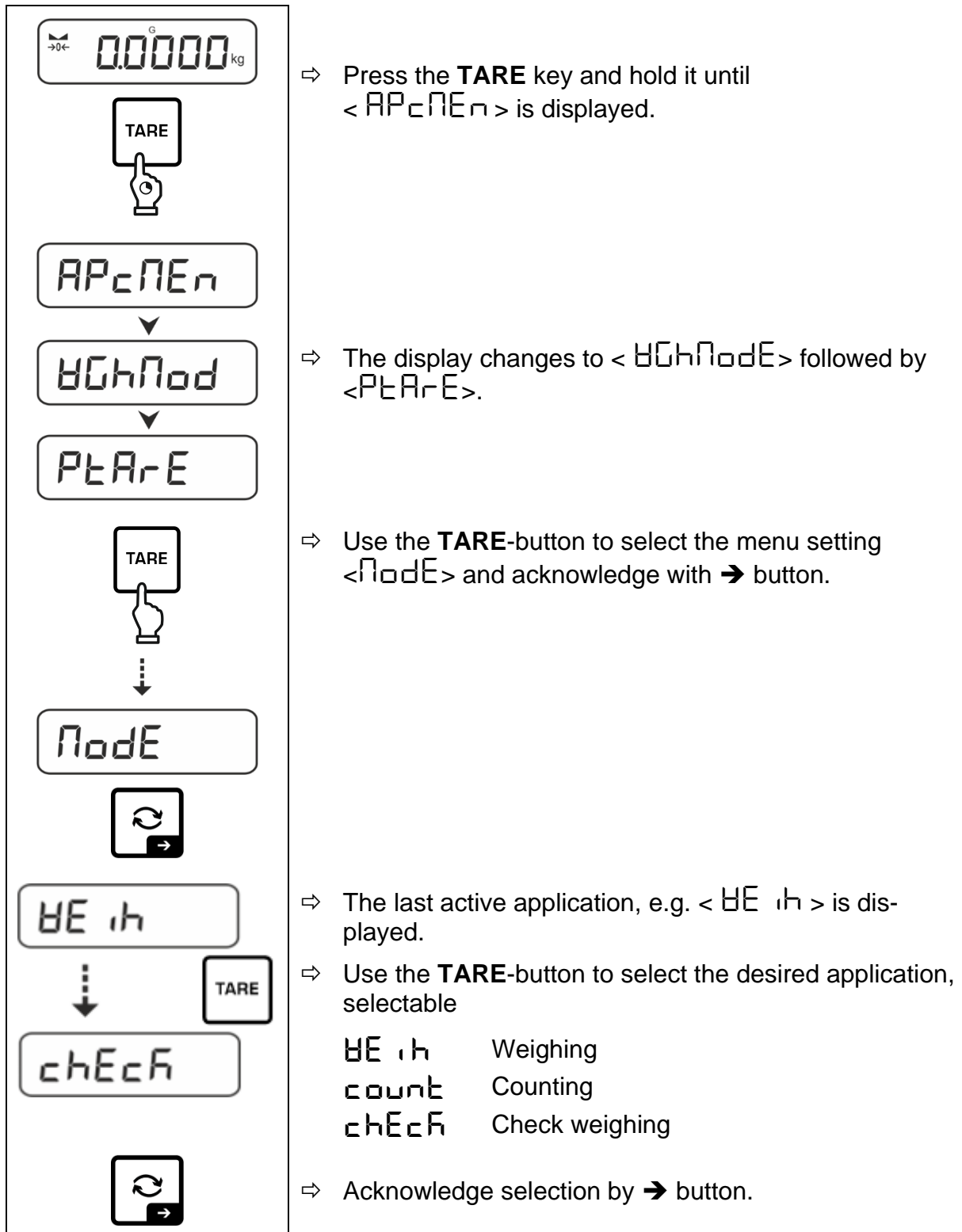

According to the selected application in the application menu just appear the application-specific settings, so that you reach the target quickly without deviation.



- Information about the application-specific settings you will find in the description of the respective application.
- All basic settings and parameters, which influence the whole operation of the balance, are resumed in the **Setup Menu** (see chap. 14.3.1) These settings remain valid for all applications.
- The number of the available applications depends on the model.

### Change application:

- ⇒ Press the **TARE** button and keep it pressed until the first menu item of the setup menu will be displayed
- ⇒ Use the **↓** button to select the menu setting **< Mode >** and acknowledge with **→** button. The current setting will be displayed.
- ⇒ Press the **↓** button to select the required unit and confirm by pressing the **→** button.

## 11 Application <Weighing>

How to carry out a simple weighing and taring, please refer to chap. 9.2 or 9.4. Further specific settings you will find in the following chapters.

**i** Shouldn't the application <Weighing> already be enabled, select the menu setting < **Mode** > → < **WE ih** >, see chap. 10

### 11.1 Application-specific settings

#### Call up menu:

- ⇒ Press the **TARE** key and hold it until < **APcPEr** > is displayed.
- ⇒ The display changes to < **WEihMode** > followed by < **PRE-TARE** >.
- ⇒ Navigation in menu see chap. 14.1

#### Overview (not verifiable models):

Level 1	Level 2	Level 3	Description / Chapter
<b>PRE-TARE</b> PRE-TARE	<b>ACTUAL</b>		Take over the placed weight as PRE-TARE value,, see chap. 11.2.1
	<b>NUMERICAL</b>		Numerical input of the tare weight, see chap. 11.2.2
	<b>CLEAR</b>		Delete PRE-TARE value
<b>hold</b>	-		Start-Hold function, see chap. 11.3
<b>units</b> Units	available weighing units, see chap. 1		This function defines in which weighing unit the result will be displayed, see chap. 11.4.1
	<b>pcs</b>		Application unit counting
	<b>FFA</b>		Multiplication factor see chap. 11.4.2
	<b>%</b>		Application unit for determining percentages see chap. 11.4.3
<b>Mode</b> Applications	<b>WE ih</b>	Weighing	see chap. 10
	<b>count</b>	Counting	
	<b>check</b>	Check weighing	

**Overview (verifiable models):**









Level 1	Level 2	Level 3	Description / Chapter
PRE-TARE	ACTUAL	Take over the placed weight as PRE-TARE value, see chap. 11.2.1	
	NUMERICAL	Numerical input of the tare weight, see chap. 11.2.2	
	CLEAR	Delete PRE-TARE value	
hold	-	Start-Hold function, see chap. 11.3	
units	g	This function defines in which weighing unit the result will be displayed, see chap. 11.4.1	
	kg		
Applications	WEIGH	Weighing	see chap. 10
	COUNT	Counting	
	CHECK	Check weighing	



## 11.2 PRE-Tare

### 11.2.1 Take over the placed weight as PRE-TARE value

< P T A R E > → < A C T U A L >

	⇒ Deposit weighing container
	⇒ Invoke menu setting < P T A R E > and confirm by → button.
	⇒ To take over the placed weight as a PRE-TARE value, use the navigation keys ↓↑ to select < A C T U A L >
	⇒ Acknowledge by → button. < H A I T > is displayed.
	⇒ The weight of the weighing container is stored as tare weight. Zero display and indicators <PTARE> and <NET> will appear.
	
	
	⇒ Remove the weighing container, the tare weight will appear with negative sign.
	⇒ Place the filled weighing container.
	⇒ Wait until the stability display appears (▬).
	⇒ Read net weight.

**i** The entered tare weight remains valid until a new tare weight is input. To delete press the TARE key or confirm the menu setting < C L E A R > using the → button.

### 11.2.2 Enter the known tare weight numerically

< P T A R E > → < N A R U A L >

	⇒ Invoke menu setting < P T A R E > and confirm by → button.
	⇒ Using the navigation keys ↑↓ select the setting Select < N A R U A L > and confirm by pressing the → button.
	⇒ Enter known tare weight, numerical input see chap. 3.2.2, the active digit flashes.
↓	
	⇒ The input weight is saved as tare weight, the indicators < P T A R E > and < N E T > and the tare weight with minus sign will appear.
	⇒ Place the filled weighing container. ⇒ Wait until the stability display appears (▢). ⇒ Read net weight.

**i** The entered tare weight remains valid until a new tare weight is input. To delete enter the zero value or confirm the menu setting < C L E A R > using the → button.

### 11.3 Data-Hold function

	⇒ Menu setting < h o L d >
	⇒ Place goods to be weighed. ⇒ Acknowledge by → button.
	⇒ The first stable weight value is symbolised by [HOLD] in the upper edge of the display. After the load is removed, the value is left in the display for another 10 seconds.

## 11.4 Weighing Units

### 11.4.1 Setting weighing unit

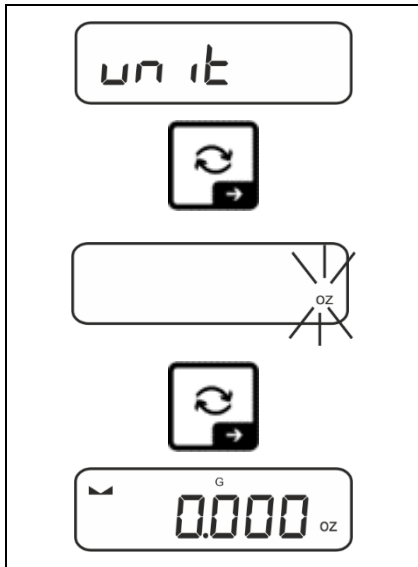

⇒ Select menu setting < unit > and confirm on → button.

⇒ Wait until the display flashes.

⇒ Use the navigation keys ↓↑ to select the weighing unit and confirm on → button.

### **i**

- For the required settings of an application unit (FFA, %) selection, please see chap. 11.4.2 and 11.4.3.
- Using the ↻ button (standard setting) you can switch between the active unit 1 and unit 2 (standard setting of buttons, see chap. 9.5. Other setting options, see chap. 14.3.1.

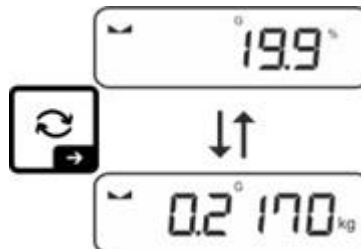

### 11.4.2 Weighing with multiplication factor via the application unit <FFA>

Here you determine with which factor the weighing result (in gram) will be multiplied. By that way, e.g. a known error factor in the weight determination can be immediately taken into account.

⇒ Select menu setting < unit > and confirm on → button.

⇒ Use the navigation keys ↓↑ to select the setting < FFA > and confirm on → button.

⇒ Enter multiplication factor, numerical input see chap. 3.2.2, the active digit flashes.

### 11.4.3 Percent weighing by application unit <%>

The application unit <%> allows to check the weight of a sample in percent, based on a reference weight.

⇒ Select menu setting < unit >.

⇒ Place a reference weight which corresponds to 100 %

at the upper display margin ⇒ Acknowledge by → button.

⇒ Use the navigation keys ↓↑ to select the setting < % > and confirm on → button.

at the upper display margin

⇒ Confirm the flashing weight value of the reference weight using → button.

⇒ From now on the weight of the sample will be shown in percent based on the reference weight

## 12 Application <Counting>



Shouldn't the application <Counting> already be enabled, select the menu setting <MODE> → <count>, see chap. 10

### 12.1 Application-specific settings

#### Call up menu:

- ⇒ Press the **TARE** key and hold it until <APPLICATION> is displayed.
- ⇒ The display changes to <count> followed by <REF>.
- ⇒ Navigation in menu see chap. 14.1

#### Overview:

Level 1	Level 2	Level 3	Description / Chapter
REF Reference quantity	5	Reference quantity 5	
	10	Reference quantity 10	
	20	Reference quantity 20	
	50	Reference quantity 50	
	FREE	Optional, numerical input, see chap. 3.2.2	
	input	Input of piece weight, numerical input, see chap. 3.2.2	
PRE-TARE PRE-TARE	ACTUAL	Take over the placed weight as PRE-TARE value, see chap. 11.2.1	
	NUMAL	Numerical input of the tare weight, see chap. 11.2.2	
	clear	Delete PRE-TARE value	
TARGET Target counting	VALUE	Counting mode	see chap. 12.2.2
	ERRUPP	Upper tolerance	
	ERRLOD	Lower tolerance	
	clear	Delete settings	
MODE Applications	count	Counting	see chap. 10
	check	Check weighing	
	WEIGH	Weighing	

## 12.2 Using the application

### 12.2.1 Piece counting

Before the balance can count parts, it must know the average part weight (i.e. reference). Proceed by putting on a certain number of the parts to be counted. The balance determines the total weight and divides it by the number of parts, the so-called reference quantity. Counting is then carried out on the basis of the calculated average piece weight.



- i** • The higher the reference quantity the higher the counting exactness.
- Especially high reference must be selected for small parts or parts with considerably different sizes.
- Smallest counting weight see table „Technical data“.

#### 1. Set reference

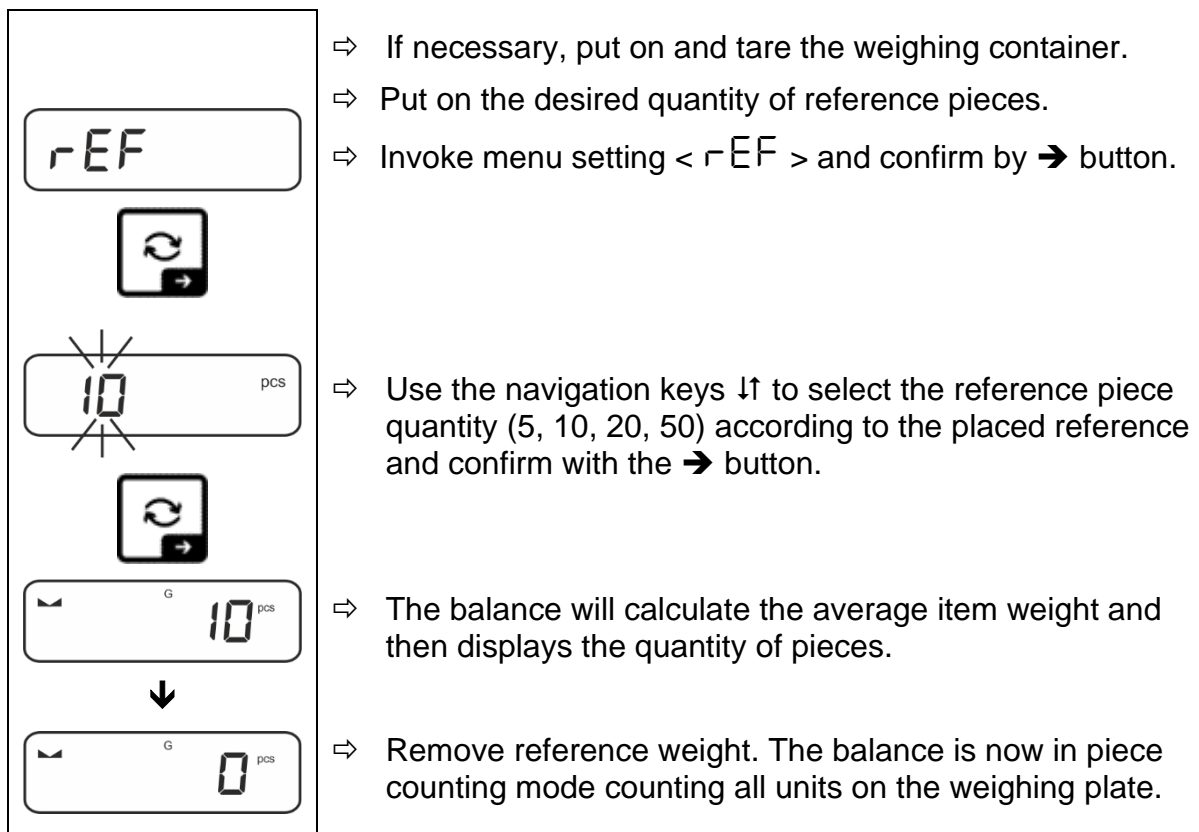

##### Reference quantity 5, 10, 20 or 50:



### Reference quantity user-defined:

rEF	⇒ If necessary, put on and tare the weighing container.
	⇒ Put on the desired quantity of reference pieces.
FrEE pcs	⇒ Invoke menu setting < ref > and confirm by → button.
	⇒ Use the navigation keys ↓↑ to select the setting < FrEE > and confirm on → button.
000033 pcs	⇒ The numeric input window appears.
00033 pcs	⇒ Enter and confirm the quantity of the placed reference parts, numerical input see chap. 3.2.2
↓	⇒ The balance will calculate the average item weight and then displays the quantity of parts.
G 0 pcs	⇒ Remove reference weight. The balance is now in piece counting mode counting all units on the weighing plate.

### Counting with optional piece weight:

rEF	⇒ Invoke menu setting < rEF > and confirm on → button.
	⇒ Use the navigation keys ↓↑ to select the setting < inPut > and confirm on → button.
inPut	⇒ Use the navigation keys ↓↑ to select the weighing unit and confirm on → button.
	⇒ Use the navigation keys ↓↑ to select the comma position and confirm on → button.
00034 kg	⇒ Use the navigation keys ↓↑ to select the comma position and confirm on → button.
3.4 g	⇒ Use the navigation keys ↓↑ to select the comma position and confirm on → button.

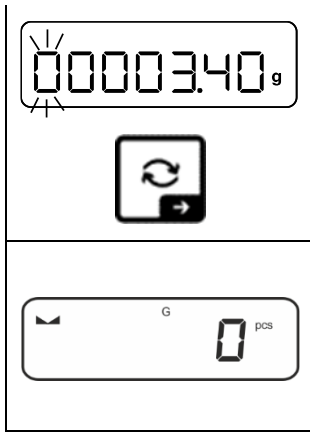

- ⇒ Enter piece weight, numerical input see chap. 3.2.2, the active digit flashes.
- ⇒ Acknowledge by → button.

The balance is now in piece counting mode counting all units on the weighing plate.

## 2. Parts counting

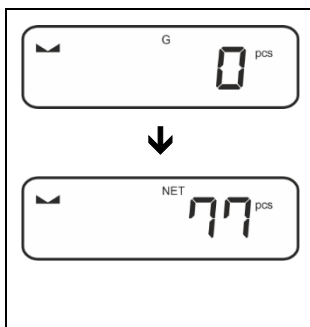

- ⇒ If necessary, put on and tare the weighing container.
- ⇒ Fill the counting quantity. The piece quantity is shown directly in the display.

**i** Use the ↻ to switch between piece quantity and weight display (standard setting see chap. 9.5).

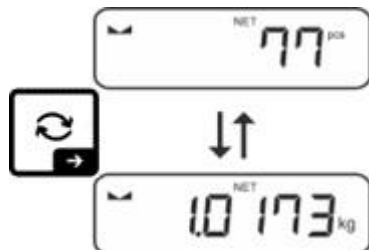





### 12.2.2 Target counting

The <Target counting> application variant allows weighing of goods within set tolerance limits in keeping with a determined target quantity.

Reaching the target quantity is indicated by an acoustic (if activated in menu) and an optic signal (tolerance marks).

#### Optical signal:

The tolerance marks provide the following information:

















	Target quantity exceeds defined tolerance
	Target quantity within defined tolerance
	Target quantity below defined tolerance

#### Acoustic signal:

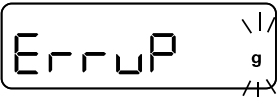
The acoustic signal depends on the menu setting <SETUP → BEEPER >, see chap. 14.3.1.

**Procedure:**

**1. Define target quantity and tolerances**

	⇒ Make sure that the scale is in counting mode and that an average piece weight has been defined (see chap. 12.2.1). If necessary, switch over with the  button.
	⇒ Use the navigation keys $\uparrow$ to select the setting < TARGET > and confirm with $\rightarrow$ button.
	
	< VALUE > is displayed.
	⇒ Confirm on $\rightarrow$ button, the numeric input window appears. The active digit is flashing.
	⇒ Enter the target quantity (numerical input see chap. 0) and confirm the entry.
	
	The balance returns to the < VALUE > menu.
	⇒ Use the navigation keys $\uparrow$ to select the setting < ERRUPP > and confirm on $\rightarrow$ button.
	
	⇒ Use the navigation keys $\uparrow$ to select the weighing unit and confirm on $\rightarrow$ button.
	⇒ The numeric input window appears. The active digit is flashing.
	⇒ Enter the upper tolerance (for numerical input see chap. 0) and confirm the entry.
	
	The balance returns to the < ERRUPP > menu.
	

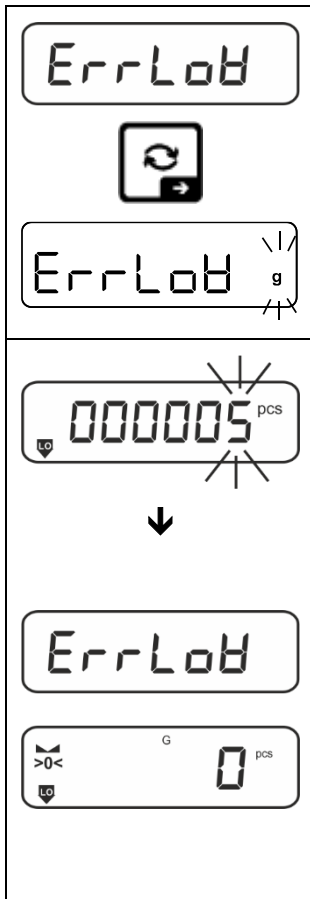

- ⇒ Use the navigation keys  $\uparrow\downarrow$  to select the setting  $\langle \text{ErrLoB} \rangle$  and confirm on  $\rightarrow$  button.
- ⇒ Use the navigation keys  $\uparrow\downarrow$  to select the weighing unit and confirm on  $\rightarrow$  button.
- ⇒ The numeric input window appears. The active digit is flashing.
- ⇒ Enter the lower tolerance (for numerical input, see chap. 0) and confirm the entry.
- ⇒ The balance returns to the  $\langle \text{ErrLoB} \rangle$  menu.
- ⇒ Press repeatedly  $\leftarrow$  button to exit menu.

Finished the setting works, the weighing balance will be ready for target counting.

## 2. Start tolerance check:

- ⇒ Determine the average piece weight, see chap. 12.2.1
- ⇒ Place the weighed material and check by means of the tolerance marks / acoustic signal if the weighed material is within the defined tolerance.

Load below specified tolerance	Load within specified tolerance	Load exceeds specified tolerance



The entered values will remain valid until new values are entered.

To delete the values, select menu setting  $\langle \text{EArGEt} \rangle \rightarrow \langle \text{cLEAR} \rangle$  and confirm on  $\rightarrow$  button.

## 13 Application < Checkweighing >



Shouldn't the application <Checkweighing> already be enabled, select the menu setting < **Mode** > → < **check** >, see chap. 10

### 13.1 Application-specific settings

#### Call up menu:

- ⇒ Press the **TARE** key and hold it until < **APCNE** > is displayed.
- ⇒ The display changes to < **checkmode** > followed by < **L iL** >.
- ⇒ Navigation in menu see chap. 14.1

#### Overview:

Level 1	Level 2	Level 3	Description / Chapter
<b>TARE</b> Target weighing, see chap. 13.2.1	<b>VALUE</b>	Target weight, numerical input, see chap. 3.2.2	
	<b>ERRUP</b>	Upper tolerance, numerical input see chap. 3.2.2	
	<b>ERRLO</b>	Lower tolerance, numerical input see chap. 3.2.2	
	<b>clear</b>	Delete settings	
<b>L iL</b> check weighing, see chap. 13.2.2	<b>L iUP</b>	Upper limit value, numerical input see chap. 3.2.2	
	<b>L iLO</b>	Lower limit value, numerical input see chap. 3.2.2	
	<b>clear</b>	Delete settings	
<b>PRE-TARE</b> PRE-TARE	<b>ACTUAL</b>	Take over the placed weight as PRE-TARE value, see chap.11.2.1	
	<b>NORMAL</b>	Numerical input of the tare weight, see chap. 11.2.2	
	<b>clear</b>	Delete PRE-TARE value	
<b>Mode</b> Applications	<b>WE i</b>	Weighing	see chap. 10
	<b>count</b>	Counting	
	<b>check</b>	Check weighing	

## 13.2 Using the application



### 13.2.1 Target weighing

The <target weighing> application variant allows weighing of goods within set tolerance limits in keeping with a determined target weight.

Reaching the target weight is indicated by an acoustic (if activated in menu) and an optic signal (tolerance marks).

#### Optic signal:

The tolerance marks provide the following information:













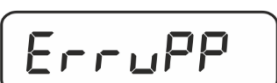

	Upper limit
	Target weight
	Lower limit

#### Acoustic signal:

The acoustic signal depends on the menu setting <SETUP → BEEPER >, see chap. 0.

## Procedure:

### 1. Define target weight and tolerances

	⇒ Use the navigation keys $\uparrow\downarrow$ to select the setting < TARGET > and confirm with $\rightarrow$ button.
	
	< VALUE > is displayed.
	⇒ Confirm on $\rightarrow$ button, the numeric input window appears. The active digit is flashing.
	⇒ Enter target weight (numerical input see chap. 3.2.2) and confirm the entry.
	
	The balance returns to the < VALUE > menu.
	⇒ Use the navigation keys $\uparrow\downarrow$ to select the setting < ERRUPP > and confirm on $\rightarrow$ button.
	
	⇒ Use the navigation keys $\uparrow\downarrow$ to select the weighing unit and confirm on $\rightarrow$ button.
	⇒ The numeric input window appears. The active digit is flashing.
	⇒ Enter the upper limit for the weight deviation (numerical input see chap. 3.2.2) and confirm the entry.
	
	The balance returns to the < ERRUPP > menu.
	

	⇒ Use the navigation keys $\uparrow$ to select the setting $\langle \text{ErrLoD} \rangle$ and confirm on $\rightarrow$ button.
	⇒ Use the navigation keys $\uparrow$ to select the weighing unit and confirm on $\rightarrow$ button.
	⇒ The numeric input window appears. The active digit is flashing.
	⇒ Enter lower limit for weight deviation (numerical input see chap. 3.2.2) and confirm the entry.
	⇒ The balance returns to the $\langle \text{ErrLoD} \rangle$ menu.
	⇒ Press repeatedly $\leftarrow$ button to exit menu.

Finished the setting works, the weighing balance will be ready for checkweighing.

### 3. Start tolerance check:

- ⇒ Place the weighed material and check by means of the tolerance marks / acoustic signal if the weighed material is within the defined tolerance.

Load below specified tolerance	Load within specified tolerance	Load exceeds specified tolerance

- i** The entered values will remain valid until new values are entered.  
To delete the values, select menu setting  $\langle \text{EArGEt} \rangle \rightarrow \langle \text{cLEAR} \rangle$  and confirm on  $\rightarrow$  button.



### 13.2.2 Checkweighing

With the <Checkweighing> application variant you can check if the weighing good is within a predefined tolerance range.

When limit values are exceeded below or above, an acoustic signal (if enabled in menu) will sound and an optic signal (tolerance marks) will be displayed

#### Optic signal:

The tolerance marks provide the following information:

	Weighed-in goods exceed predefined tolerance
	Weighed-in goods within predefined tolerance
	Weighed-in goods below predefined tolerance

#### Acoustic signal:

The acoustic signal depends on the menu setting <SEtUP> → <BEEPER>, see chap. 14.3.1.

#### Procedure:

##### 1. Define limit values

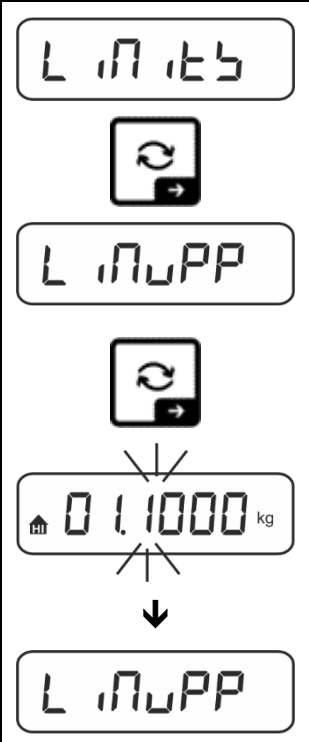

⇒ Using the navigation keys ↓↑ select the setting  
Select < L 17.15 > and confirm on → button.

< L 17.00 > will appear.

⇒ Press → button to confirm, the numeric input window for entering the upper limit value will appear.  
The active digit is flashing.

⇒ Enter upper limit value (numerical input see chap. 3.2.2) and confirm the entry.

The balance returns to the < L 17.00 > menu.



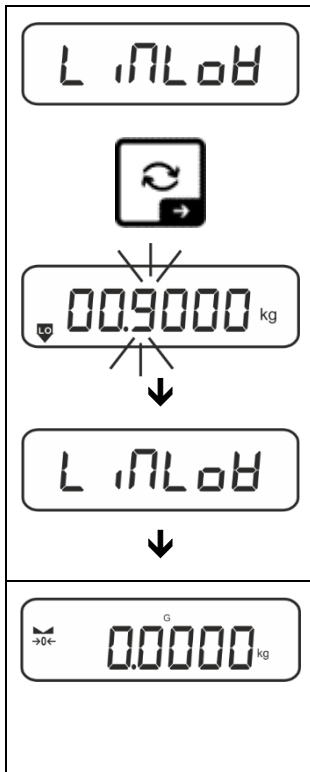

⇒ Use the navigation keys  $\uparrow$  to select setting  $\langle L \ iNLob \rangle$ .

⇒ Press  $\rightarrow$  button to confirm, the numeric input window for entering the lower limit value will appear. The active digit is flashing.

⇒ Enter lower limit value (numerical input see chap. 3.2.2) and confirm the entry.

The balance returns to the  $\langle L \ iNLob \rangle$  menu.

⇒ Press repeatedly  $\leftarrow$  button to exit menu.

Finished the setting works, the weighing balance will be ready for checkweighing.

## 2. Start tolerance check:

⇒ Place the weighed material and check by means of the tolerance marks / acoustic signal if the weighed material is within the defined tolerance.

Load below specified tolerance	Load within specified tolerance	Load exceeds specified tolerance



The entered values will remain valid until new values are entered.

To delete the values, select menu setting  $\langle L \ iNLob \rangle \rightarrow \langle CLEAR \rangle$  and confirm on  $\rightarrow$  button.

## 14 Menu

### 14.1 Navigation in the menu

Call up menu:

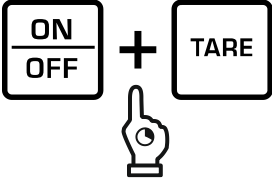
Application menu	Setup menu
 <p>Press the <b>TARE</b> button and keep it pressed until the first menu item will be displayed</p>	 <p>Press the <b>TARE</b> and <b>ON/OFF</b> button at the same time and keep them pressed until the first menu item will be displayed</p>

Select and adjust parameters:

<p><b>Scrolling on one level</b></p>	<p>Use the navigation buttons to select the individual menu blocks one by one. Use the navigation key ↓ to scroll down. Use the navigation key ↑ to scroll up.</p>
<p><b>Activate menu item / Confirm selection</b></p>	<p>Press navigation key →</p>
<p><b>Menu level back / back to weighing mode</b></p>	<p>Press navigation key ←</p>

### 14.2 Application menu

The application menu allows you a fast and targeted access to the respectively selected application (see chap. 10).



An overview of the application-specific settings you will find in the description of the respective application.

### 14.3 Setup menu

In the setup menu you have the possibility to adapt the behaviour of the balance to your requirements (e.g. environmental conditions, especial weighing processes).

These settings are global and do not depend on the selected application (with exception of: <bUttOn>).

#### 14.3.1 Overview <SEtUP>

Not verifiable models:

Level 1	Level 2	other levels / description	
		Description	
cAL Adjustment	cALEHt	→ External adjustment, see chap. 7.7.1	
	cALEud	→ External adjustment, user-defined, see chap. 7.7.2	
	GrARdJ	→ Gravity constant adjustment site, see chap.7.7.3	
	GrAubE	→ Gravity constant installation site, see chap. 7.7.4	
cOn Communication	r5232 ↓ ubb-d	bAud	600
			1200
			2400
			4800
			9600
			14400
			19200
			38400
			57600
			115200
			128000
		256000	
		dAtA	7db t5
	8db t5		
	PAR t5	nonE	
		odd	
		EUEn	
	StoP	15b t	
		25b t5	
	hAndsh	nonE	
Protoc	FcP		
AnA-oP	0-10U	0 – 10 V	
	4-20mA	4 – 20 mA	
BLAn	on	WiFi on	
	oFF	WiFi off	

Print Data output	interface		rs232	RS 232 interface*					
			usb-d	USB interface*					
			wlan	WiFi interface*					
			lan	Ethernet interface* *only in connection with KUP interface					
	sum		on	Switch on / off add-up mode, see chap. 15.3.1					
			off						
	Print mode		trigger	MANUAL	on, off Data output by pressing the <b>PRINT</b> button, see chap. 15.3.2				
				AutoPr	on, off Automatic data output with stable and positive weighing value see chap.15.3.3. Another output only af- ter zero display and stabilisation, de- pending on the settings < RANGE >, selectable (off, 1, 2, 3,4,5). < RANGE > defines the factor for d. This factor multiplied with d results in the threshold; when it is exceeded, a value cannot more be con- sidered as stable.				
				cont	off	Continuous data output			
					on	SPEED	Setting output interval see chap. 15.3.4		
						ZERO	on, off 0 (unloaded) also transmit continuously		
						STABLE	on, off Transmit stable values only		
				weight		SGLPrE		on, off	Displayed weight value is transmitted
						ContPrE		Grabb	on, off
								net	on, off
tARE								on, off	
ForNAt	Long (detailed measu- rement protocol)								
				short (standard mea- surement protocol)					

		LAYout	nonE	on, off Standard layout	
			u5Er	Model	on, off Output model designation of the scale
				Serial	on, off Output serial number of the scale
				AL id	Alibi-ID output
				DATE	Date output
				TIME	Time output
		rE5Et	no	Do not delete settings	
			YES	Delete settings	

bEEPEr Acoustic signal	REYb	oFF	Switch on / off acoustic signal by pressing button		
		on			
	chEcH	ch-on	oFF	Acoustic signal off	
			bLoB	Slow	
			bEd	Standard	
			FASt	Fast	
			cont.	Continuous	
		ch-Lo	oFF	Acoustic signal off	
			bLoB	Slow	
			bEd	Standard	
			FASt	Fast	
			cont.	Continuous	
		ch-hi	oFF	Acoustic signal off	
			bLoB	Slow	
bEd	Standard				
FASt	Fast				
cont.	Continuous				
AutoFF Automatic switch-off function in rechargeable battery operation	Node	oFF	Automatic switch-off function switched off		
		Auto	The balance is automatically switched-off according to the time without load change or without operation defined in menu item < t .nE >		
		onLY0	Automatic switch-off only with zero display		
	t .nE	30b	After the set time without load change or operation the balance will switch off automatically		
		1n in			
		2n in			
		5n in			
		30n in			
60n in					

button Key allocation	F1-KEY ⇕ F2-KEY ⇕ CHANGE	↳Push ⇕ ↳Push	default	Standard settings, see chap. 9.5
			off	Button disabled
			unit	Set weighing unit, see chap. 11.4.1
			mode	Select weighing application, see chap. 10
			hold	Execute HOLD function, s.Kap. 11.3 *only for the application <Weighing>
			PRE	Open PRE-Tare settings, see chap. 11.2 *only for the applications <Weighing>, <Checkweighing>
			REF	Set reference quantity, see chap. 12.2.1 *only for the application <Counting>
			limits	Open settings for checkweighing, see chap. 13.2.2 *only for the application <Checkweighing>
			target	Open settings for target weighing, see chap. 13.2.1 *only for the application <Checkweighing>
BLIGHT Display background illumination	mode	ALWAYS	Background lighting of display is switched on permanently	
		timer	The background illumination is automatically switched-off according to the time without load change or without operation defined in menu item < timer >	
		noBL	Display background illumination always switched off	
	timer	5s	Definition, after which time the background illumination is automatically switched-off without load change or without operation.	
		10s		
		30s		
		1min		
		2min		
		5min		
	30min			

<p>ፎላራ ስርዓት Taring range</p>	<p>100% ⇕ 10%</p>	<p>Definition max. taring range, selectable 10% - 100%. Numerical input see chap. 3.2.2</p>	
<p>ደብዳቤ Zero tracking</p>	<p>ON</p>	<p>Automatic zero tracking [ ≤3d ]</p>	
	<p>OFF</p>	<p><b>i</b></p>	<p>In the event that small quantities are removed or added to the material to be weighed, incorrect weighing results can be displayed due to the “stability compensation”. (e.g. slow flow of liquids from a container placed on the balance, evaporating processes).  When apportioning involves small variations of weight, it is advisable to switch off this function.</p>
<p>ቀንና ሰዓት Date and time</p>	<p>ዓመት</p>	<p>-2022-</p>	<p>Enter the year</p>
	<p>ወርና ቀን</p>	<p>12-31</p>	<p>Enter the month and the day</p>
	<p>ሰዓት</p>	<p>23.59.59</p>	<p>Enter the time (hours, minutes, seconds)</p>
<p>ህድህድ Units</p>	<p>available weighing units / application units, see chap. 1</p>	<p>ON, OFF</p>	<p>Using this function you can define which weighing units are available in the application-specific menu &lt;ህድህድ&gt;. The units selected by &lt;ON&gt; are available in the application-specific menu.</p>
<p>ጠቅላይ Weighing applications</p>	<p>ዕድል</p>	<p>Weighing</p>	
	<p>ቀን</p>	<p>Counting</p>	
	<p>ጠቅላይ</p>	<p>Check weighing</p>	
<p>ፍጥነት</p>	<p>Reset balance settings to factory settings</p>		



Verifiable models:

Level 1	Level 2	other levels / description	
		Description	
עֹפּ Communication	רֵבֵּב ⚡ טֵבֵּב-ד	בִּרְבֵּב	600
			1200
			2400
			4800
			9600
			14400
			19200
			38400
			57600
			115200
			128000
		256000	
		דָּבֵּב	7db טֵבֵּב
			8db טֵבֵּב
		פָּרֵּב טֵבֵּב	nonE
			odd
			EVEN
		טֵבֵּב	15b טֵבֵּב
	25b טֵבֵּב		
	הִרְבֵּב	nonE	
	Protoc	AcP	
	אִרְבֵּב-טֵבֵּב	0-10V	0 – 10 V
4-20mA		4 – 20 mA	
טֵבֵּב	on	WiFi on	
	off	WiFi off	

Print Data output	intFcE		rs232	RS 232 interface*				
			usb-d	USB interface*				
			WLAN	WLAN interface*				
			LAN	Ethernet interface* *only in connection with KUP interface				
	sum		on	Switch on / off add-up mode, see chap. 15.3.1				
			off					
	PrintMode	trig	MANUAL	on, off				
				Data output by pressing the <b>PRINT</b> button, see chap. 15.3.2				
			AutoPr	on, off				
				Automatic data output with stable and positive weighing value see chap.15.3.3. Another output only af- ter zero display and stabilisation, de- pending on the settings < TRANGE >, selectable (off, 1, 2, 3,4,5). < TRANGE > defines the factor for d. This factor multiplied with d results in the threshold; when it is exceeded, a value cannot more be con- sidered as stable.				
				cont	off	Continuous data output		
			on		SPEED	Setting output interval see chap. 15.3.4		
				ZERO	on, off 0 (unloaded) also transmit continuously			
			WEIGHT	SGLPrE	on, off			Displayed weight value is transmitted
					GntPrE	Gross	on, off	
net				on, off				
tARE	on, off							
ForNAt	Long (detailed measu- rement protocol)							
	Short (standard mea- surement protocol)							

		LAYOUT	none	on, off Standard layout		
			user	Model	on, off	Output model designation of the scale
				Serial	on, off	Output serial number of the scale
				Alibi ID		Alibi-ID output
				Date		Date output
				Time		Time output
			GLP	on, off GLP compliant weighing protocol output		
	RESET		no	Do not delete settings		
			yes	Delete settings		

bEEPEr Acoustic signal	REYb	oFF	Switch on / off acoustic signal by pressing button		
		on			
	chEcH	ch-on	oFF	Acoustic signal off	
			bLoB	Slow	
			bEd	Standard	
			FASt	Fast	
			cont.	Continuous	
		ch-Lo	oFF	Acoustic signal off	
			bLoB	Slow	
			bEd	Standard	
			FASt	Fast	
			cont.	Continuous	
		ch-hi	oFF	Acoustic signal off	
bLoB			Slow		
bEd	Standard				
FASt	Fast				
cont.	Continuous				
AutoFF Automatic switch-off function in rechargeable battery operation	Node	oFF	Automatic switch-off function switched off		
		Auto	The balance is automatically switched-off according to the time without load change or without operation defined in menu item < t .nE >		
		onLY0	Automatic switch-off only with zero display		
	t .nE	30b	After the set time without load change or operation the balance will switch off automatically		
		1n in			
		2n in			
		5n in			
		30n in			
60n in					

button Key allocation	F1-KEY ⇕ F2-KEY ⇕ CHANGE	↳Push ⇕ ↳Push	default	Standard settings, see chap. 9.5
			off	Button disabled
			unit	Set weighing unit, see chap. 11.4.1
			mode	Select weighing application, see chap. 10
			hold	Execute HOLD function, s.Kap. 11.3 *only for the application <Weighing>
			PRE	Open PRE-Tare settings, see chap. 11.2 *only for the applications <Weighing>, <Checkweighing>
			REF	Set reference quantity, see chap. 12.2.1 *only for the application <Counting>
			limits	Open settings for checkweighing, see chap. 13.2.2 *only for the application <Checkweighing>
			target	Open settings for target weighing, see chap. 13.2.1 *only for the application <Checkweighing>
BLIGHT Display background illumination	mode	ALWAYS	Background lighting of display is switched on permanently	
		timer	The background illumination is automatically switched-off according to the time without load change or without operation defined in menu item < timer >	
		noBL	Display background illumination always switched off	
	timer	5s	Definition, after which time the background illumination is automatically switched-off without load change or without operation.	
		10s		
		30s		
		1min		
		2min		
		5min		
30min				

<b>ժԱԷ յՈԷ</b> Date and time	<b>ՆԷԷ</b>	-2022-	Enter the year
	<b>ժԱԲՕՐՈ</b>	12-31	Enter the month and the day
	<b>Է յՕՐՈ</b>	2359.59	Enter the time (hours, minutes, seconds)
<b>ՍՈ ԷՆ</b> Units	available weighing units / application units, see chap. 1	<b>ՕՈ, ՕԲԲ</b> Using this function you can define which weighing units are available in the application-specific menu < ՍՈ ԷՆ >. The units selected by < ՕՈ > are available in the application-specific menu.	
<b>ՈժԸՆ</b> Weighing applications	<b>ԽԷ յԻ</b>	Weighing	
	<b>ԸՕՍՆԷ</b>	Counting	
	<b>ՇԻԷՇԻ</b>	Check weighing	
<b>ՐԷՆԷԷ</b>	Reset balance settings to factory settings		

## 15 Communication with peripheral devices

### 15.1 KERN Communications Protocol (KERN Interface Protocol)

KCP is a standardized set of interface orders for KERN balances, which allows many parameters and device functions to be called up and controlled. KERN devices that have KCP can use it to connect easily to computers, industrial control systems and other digital systems. A detailed description you will find in the „KERN Communications Protocol“ manual, available in the download area on our KERN homepage ([www.kern-sohn.com](http://www.kern-sohn.com)).

To activate KCP please observe the menu overview of your balance's operating instructions.

KCP is based on simple ASCII orders and replies. Every interaction consists of an order, possibly with arguments separated by spaces and finished by <CR><LF>.

The KCP orders supported by your balance may be queried emitting the order „I0“ followed by CR LF.

Extract of the mostly used KCP orders:

<b>I0</b>	Shows all implemented KCP orders
<b>S</b>	Sending stable value
<b>SI</b>	Sending current value (also instable)
<b>SIR</b>	Sending current value (also instable) and repeating
<b>T</b>	Taring
<b>Z</b>	Zeroing

Example:

<b>Order</b>	S	
<b>Possible replies</b>	S_S_____100.00_ g S_l S_+ or S_-	Order accepted, execution of the order started, currently another order is executed, timeout reached, over- or underload

## 15.2 KERN alibi memory

For weighings where verification is mandatory and which are to be analysed and processed by a PC (e.g. printing out a packing list using a PC instead of a printer connected directly to the balance) electronic archiving is required by the metrological authorities by a verifiable data memory which cannot be manipulated. These stored data strings can be retrieved & displayed at any time via a connected PC

- The Alibi memory offers the possibility to store up to 250.000 weighing results, when the memory is exhausted, already used IDs are overwritten (starting with the first ID).
- By pressing the Print key or by KCP remote control command "S" or "MEMPRT" the storage process can be performed.
- The weight value (N, G, T), date and time and a unique alibi ID are stored.
- When using a print option, the unique alibi ID is also printed for identification purposes as well.
- The stored data can be retrieved via the KCP command "MEMQID". This can be used to query a specific single ID or a series of IDs.
- Example:
  - o MEMQID 15 → The data record which is stored under ID 15 is returned.
  - o MEMQID 15 20 → All data sets, which are stored from ID 15 to ID 20, are returned.

The detailed description can be found in the *KERN Communication Protocol* manual, available in the Downloads tab on the home page of KERN ([www.kern-sohn.com](http://www.kern-sohn.com)).

<b>i</b>	<ul style="list-style-type: none"><li>- Protection of stored legally relevant data:<ul style="list-style-type: none"><li>o After a record is stored, it will be read back immediately and be verified byte by byte. If error is found that record will be marked as an invalid record. If no error, then the record can be printed if needed.</li><li>o There is checksum protection stored in every record.</li><li>o All information on a printout is read from the memory with checksum verification, instead of direct from buffer.</li></ul></li> <li>- Data loss prevention measures:<ul style="list-style-type: none"><li>o The memory is write-disabled upon power-up.</li><li>o A write enable procedure is performed before writing a record to the memory.</li><li>o After a record is stored, a write disable procedure will be performed immediately (before verification).</li><li>o The memory has a data retention period longer than 20 years.</li></ul></li></ul>
----------	---



## 15.3 Issue functions

### 15.3.1 Add-up mode < 500 >

With this function the individual weighing values are added into the summation memory by pressing a button and edited when an optional printer is connected.

#### Activate function:

- ⇒ In Setup menu invoke the menu setting < Pr Node > → < 500 > and confirm with button →.
- ⇒ Use the navigation keys ↓↑ to select the setting < 00 > and confirm on → button.
- ⇒ To exit the menu, press the navigation key ← repeatedly



Condition: Menu setting

< Pr Node > → < 00 > → < MANUAL > → < 00 >

#### Add-up weighed goods:

- ⇒ If required, place empty container on scale and tare.
- ⇒ Place first good to be weighed on balance. Wait until stability display (▲▲) appears and then press the PRINT-button. The display changes to < 500 1 >, followed by the current weighing value. The weighing value is stored and edited by the printer. The symbol Σ pops up. Remove the weighed good.
- ⇒ Place second good to be weighed on balance. Wait until stability display (▲▲) appears and then press the PRINT-button. The display changes to < 500 2 >, followed by the current weighing value. The weighing value is stored and edited by the printer. Remove the weighed good.
- ⇒ Add-up more weighed goods as described above.
- ⇒ You can repeat this process until the capacity of the scales is exhausted.

#### Display and edit sum „Total“:

- ⇒ Press the PRINT key long time. The number of weighings and the total weight are edited.  
The sum memory is deleted; the symbol [Σ] extinguishes.

**Sample log (KERN YKB-01N):**

Menu setting < PrNode > → < ForNAt > → < Short >

No.			1		First weighing
N:	S S	1.9993 kg			
T:		0.0000 kg			
G:		1.9993 kg			
C:		1.9993 kg			
No.			2		Second weighing
N:	S S	0.9992 kg			
T:		0.0000 kg			
G:		0.9992 kg			
C:		2.9985 kg			
No.			3		Third weighing
N:	S S	0.4992 kg			
T:		0.0000 kg			
G:		0.4992 kg			
C:		3.4977 kg			
No.			3		Number of weighings/ Total
C:		3.4977 kg			

**Sample log (KERN YKB-01N):**

Menu setting

< PrNode > → < BE iGht > → < SCLPrt > → < on >

No.			1		First weighing
C:	200.0 g				
No.		200.0 g	2		Second weighing
C:	500.0 g				
No.		700.0 g	3		Third weighing
C:	400.0 g				
No.		1100.0 g	4		Fourth weighing
C:	100.4 g				
No.		1200.4 g	4		Number of weighings/ Total
C:		1200.4 g			

### 15.3.2 Data output after pressing the PRINT button < ПРІНТ >

#### Activate function:

- ⇒ In Setup menu invoke the menu setting < Print > → < Print Mode > → < Enter > and confirm with → button.
- ⇒ For a manual data output select the menu setting < MANUAL > with the navigation keys ↓↑ and confirm on the → button.
- ⇒ Use the navigation keys ↓↑ to select the setting < OK > and confirm on → button.
- ⇒ To exit the menu, press the navigation key ← repeatedly.

#### Place goods to be weighed on balance:

- ⇒ If required, place empty container on scale and tare.
- ⇒ Place goods to be weighed. The weighing value is edited by pressing the PRINT-button.

### 15.3.3 Automatic data output < AUTO >

Data output happens automatically without having to press the **PRINT** button as soon as the corresponding output condition has been met, dependent on the setting in the menu.

#### Enable function and set the output condition:

- ⇒ In Setup menu invoke the menu setting <Print> → <PrintMode> → <Enter> and confirm with → button.
- ⇒ For an automatic data output select the menu setting <AUTO> using the navigation keys ↓↑ and confirm by the → button.
- ⇒ Use the navigation keys ↓↑ to select the setting <ON> and confirm on → button. <ENTER ON> is displayed.
- ⇒ Acknowledge by → button and set the required output condition with the navigation keys ↓↑.
- ⇒ Acknowledge by → button.
- ⇒ To exit the menu press the navigation key ← repeatedly.

#### Place goods to be weighed on balance:

- ⇒ If required, place empty container on scale and tare.
- ⇒ Place weighed goods and wait until the stability display (▲▲) appears. The weighing value is issued automatically.

### 15.3.4 Continuous data output < CONT >

#### Enable function and set the output interval:

- ⇒ In Setup menu invoke the menu setting <Print> → <PrintMode> → <Enter> and confirm with → button.
- ⇒ For a continuous data output select the menu setting <CONT> using the navigation keys ↓↑ and confirm on → button.
- ⇒ Use the navigation keys ↓↑ to select the setting <ON> and confirm on → button.
- ⇒ <SPEED> is displayed.
- ⇒ Acknowledge with the → button and set the required time interval with the navigation keys ↓↑ (numerical input see chap. 3.2.2)
- ⇒ Set the required output condition <ENTER> & <ENABLE>.
- ⇒ To exit the menu press the navigation key ← repeatedly.

#### Place goods to be weighed on balance

- ⇒ If required, place empty container on scale and tare.
- ⇒ Place goods to be weighed.
- ⇒ The weighing values are issued according to the defined interval.

**Sample log (KERN YKB-01N):**

S D	1.9997	kg
S D	1.9999	kg
S D	1.9999	kg
S D	1.9999	kg
S S	2.0000	kg
S S	2.0000	kg
S S	2.0000	kg
S D	1.9998	kg
S D	1.9998	kg
S D	2.0002	kg
S D	2.4189	kg
S D	2.9999	kg
S D	2.9996	kg
S D	2.9996	kg
S D	2.9997	kg
S D	2.9997	kg
S S	2.9996	kg
S S	2.9996	kg

**15.4 Data format**

- ⇒ In the setup menu call up the menu setting <Print> → <PrintMode> → <Default> → <Print> and confirm on → button.
- ⇒ Use the navigation keys ↓↑ to select the menu setting <Format> and confirm on → button.
- ⇒ Use the navigation buttons ↓↑ to select the desired setting.  
Options:
  - <Short> Standard measuring protocol
  - <Long> Detailed measuring protocol
- ⇒ Confirm setting with → button.
- ⇒ To exit the menu press the navigation key ← repeatedly.

**Sample log (KERN YKB-01N):**

Format → Short			Format → Long		
N:	S S	2.0000 kg	N:	S D	2.0000 kg
T:		0.5000 kg	Tara weight after x:		0.5000 kg
G:		2.5000 kg	Gross weight:		2.5000 kg

## 16 Servicing, maintenance, disposal



Before any maintenance, cleaning and repair work disconnect the appliance from the operating voltage.

### 16.1 Cleaning

Please do not use aggressive cleaning agents (solvents or similar agents), but a cloth dampened with mild soap suds. Ensure that no liquid penetrates into the device. Polish with a dry soft cloth.

Loose residue sample/powder can be removed carefully with a brush or manual vacuum cleaner.

**Spilled weighing goods must be removed immediately.**

### 16.2 Servicing, maintenance

- ⇒ The appliance may only be opened by trained service technicians who are authorized by KERN.
- ⇒ Before opening, disconnect from power supply.

### 16.3 Disposal

Disposal of packaging and appliance must be carried out by operator according to valid national or regional law of the location where the appliance is used.

## 17 Instant help for troubleshooting

In case of an error in the program process, briefly turn off the balance and disconnect from power supply. The weighing process must then be restarted from the beginning.

<b>Fault</b>	<b>Possible cause</b>
The weight display does not glow.	<ul style="list-style-type: none"><li>• The balance is not switched on.</li><li>• The mains supply connection has been interrupted (mains cable not plugged in/faulty).</li><li>• Power supply interrupted.</li></ul>
The displayed weight is permanently changing	<ul style="list-style-type: none"><li>• Draught/air movement</li><li>• Table/floor vibrations</li><li>• Weighing plate has contact with foreign objects.</li><li>• Electromagnetic fields / static charging (choose different location/switch off interfering device if possible)</li></ul>
The weighing result is obviously incorrect	<ul style="list-style-type: none"><li>• The display of the balance is not at zero</li><li>• Adjustment is no longer correct.</li><li>• The balance is on an uneven surface.</li><li>• Great fluctuations in temperature.</li><li>• Warm-up time was ignored.</li><li>• Electromagnetic fields / static charging (choose different location/switch off interfering device if possible)</li></ul>

## 18 Error messages

Error message	Explication
0L n t	Zero setting range exceeded
undEr0	Zero setting range not achieved
instAb	Load instable
ErOnG	Adjustment error
L---	Underload
----	Overload
Lo bAt	Capacity of batteries / rechargeable batteries exhausted